



CHANNEL SUPPORT SYSTEMS



CHANNEL SUPPORT SYSTEMS

Standard Channels

		Code Suffix
BRITISH STANDARD	Complies with BS 6946	
FULL TECHNICAL SUBMITTAL AVAILABLE ON REQUEST		
STANDARD LENGTH	3.0 metres and 6.0 metres	
STANDARD THICKNESS	2.5mm	
STANDARD FINISH	Hot-Dip Pre-Galvanised to BS EN 10346	/G

CH101
Weight 2.6 Kg/m

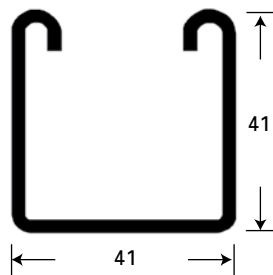

CH103
Weight 5.2 Kg/m

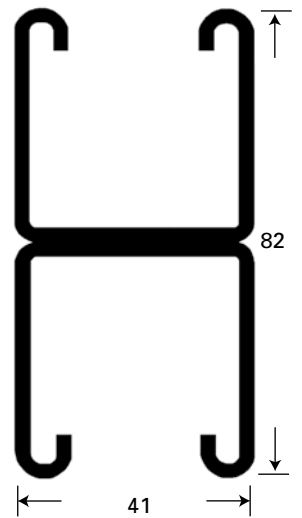

CH104
Weight 1.8 Kg/m

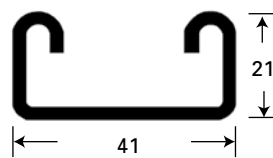

CH105
Weight 3.6 Kg/m

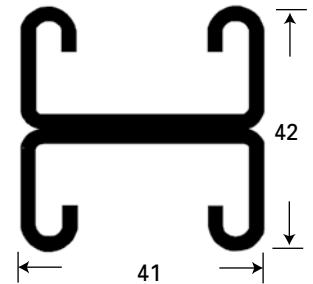

Slotted Channel

Channels are available with pre-punched slots to facilitate easy fixing.

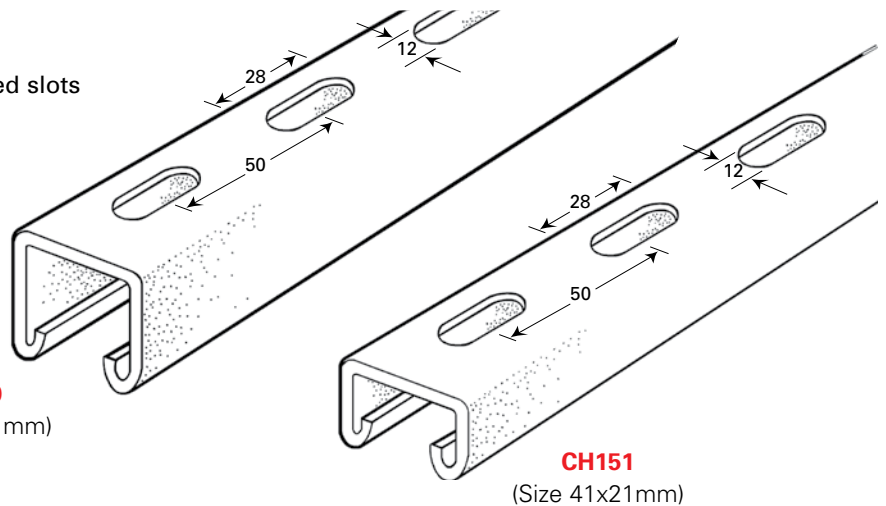

CH150
(Size 41x41mm)

CH151
(Size 41x21mm)

CHANNEL SUPPORT SYSTEMS

Supports

Cantilever Arms DIMENSION A
 150mm
 225mm
 300mm
 450mm
 600mm
 750mm

CA101

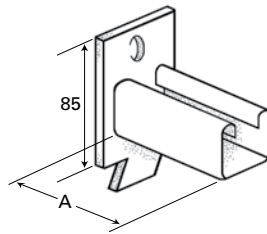

CA104

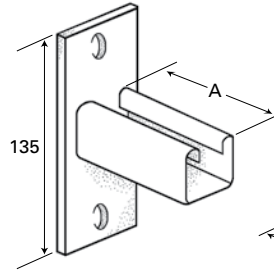

CA105

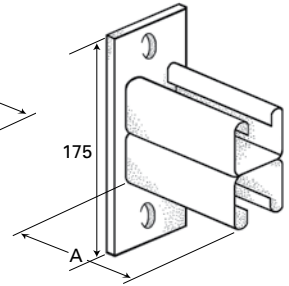

Cantilever Tray Brackets

CA106

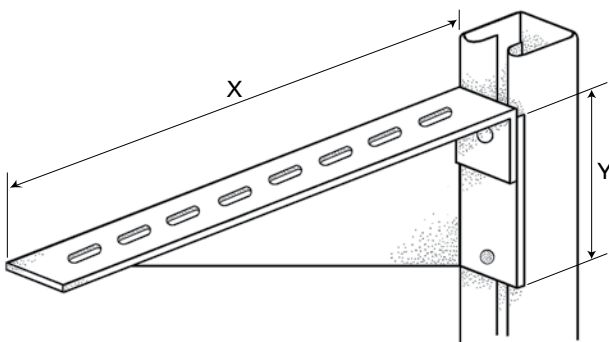

Stand-off Tray Brackets

CA107

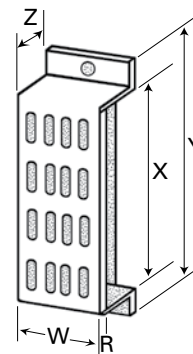

Product Code	x mm	y mm
CA106/100	100	70
CA106/150	150	70
CA106/225	225	90
CA106/300	300	90
CA106/450	450	130
CA106/600	600	130
CA106/750	750	130
CA106/900	900	130

Galvanised BS EN 10346

Product Code	x mm	y mm	z mm	w mm	Return R
CA107/50	55	105	25	55	-
CA107/75	80	130	25	55	-
CA107/100	105	155	50	55	-
CA107/150	155	205	50	55	10
CA107/225	230	280	75	55	10
CA107/300	305	355	75	55	10
CA107/450	455	505	75	55	10
CA107/600	605	655	75	55	10
CA107/750	755	805	75	55	10
CA107/900	905	955	75	55	10

Galvanised BS EN 10346

CHANNEL SUPPORT SYSTEMS

Fixings

ALL FIXINGS ARE BRIGHT ZINC PLATED
TO BS7371

Threaded Rod (Mild Steel)

FX275/
M6x3m
M8x3m
M10x3m
M12x3m



Full Hexagon Nuts

FX154/
M6
M8
M10
M12

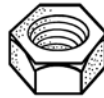

Plain Flat Washers

FX198/
INT EXT
DIA DIA
M6 12mm
M8 17mm
M10 21mm
M12 24mm



Penny / Mudguard Washers

FX202/
INT EXT
DIA DIA
M6 30mm
M8 30mm
M10 30mm



Spring Washers (Single Coil)

FX206/
M6
M8
M10
M12



Shakeproof Washers

FX213/
M6
M8
M10
M12



Hexagon Head Set Screws

FX132/
M6x12 M8x16 M10x20 M12x22
M6x16 M8x20 M10x25 M12x25
M6x20 M8x25 M10x30 M12x30
M6x25 M8x30 M10x35 M12x35
M6x30 M6x35 M10x40 M12x40
M6x35 M8x40 M10x50 M12x50
M6x40 M8x50 M10x60 M12x60
M6x50 M8x60 M10x80 M12x80
M6x60

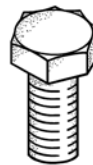

Tray Bolts & Nuts

FX281/
M6x12
M6x16
M6x20
M6x25
M6x30
M6x35
M6x40
M6x50
M6x60
M6x70

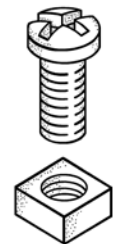

Threaded Rod Cover Caps

FX276/
M6
M8
M10
M12



Threaded Rod Connectors

FX384/
M6
M8
M10
M12



Eye Bolts

FX385/
M6x80
M8x80
M10x80
M12x80



CHANNEL SUPPORT SYSTEMS

Channel Nuts

STANDARD FINISH - BRIGHT ZINC PLATED
TO BS7371

Long Spring

CN701/



Deep Channel

CN701/6 M6
CN701/8 M8
CN701/10 M10
CN701/12 M12



Short Spring

CN702/



Shallow Channel

CN702/6 M6
CN702/8 M8
CN702/10 M10
CN702/12 M12

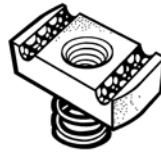

No Spring

CN703/

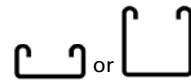

Shallow Channel or Deep Channel

CN703/6 M6
CN703/8 M8
CN703/10 M10
CN703/12 M12

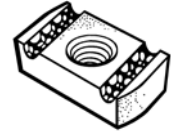

Plastic End Caps

CL505 - Black
CL515 - White

CL506 - Black
CL516 - White



Deep Channel



Shallow Channel

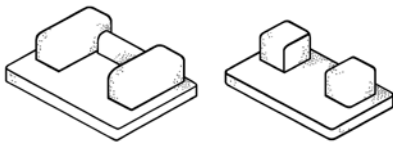

Closure Strip

CL504

/W White PVC
/G Galvanised to BS EN 10346

Supplied in 3m lengths

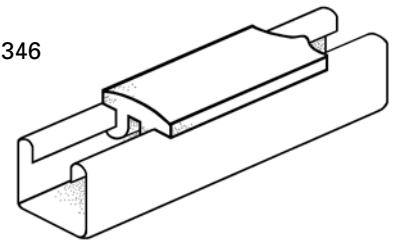

Purlin 'D' Clip

PD Hole diameter
11mm

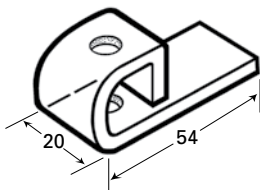

Flange Clamp

FC-1 M8
FC-2 M10
FC-3 M12

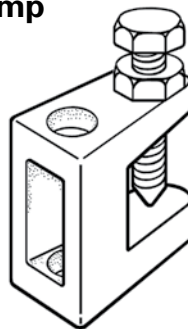

Wedge Nuts

FX400/
M6
M8
M10

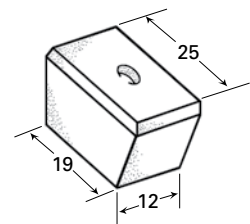

Drop-in Anchors



Product Code	Thread Size (mm)	Anchor Dia (mm)	Thread Depth (mm)	Overall Length (mm)	Setting Tool Product Code
FX366	6	8	10	25	FX372
FX367	8	10	12.75	32	FX373
FX368	10	12	16	40	FX374
FX369	12	15	16	50	FX375

Cone Pointed Set Screws

FX386
M10x40mm

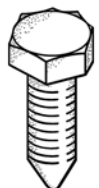

CHANNEL SUPPORT SYSTEMS

Fittings & Brackets

- Brackets comply with BS 6946
- Hot Dipped Galvanised to BS EN ISO 1461 unless otherwise stated
- All dimensions are in millimetres

Flat Plate Fittings

- CB101/6** (M6 fixing)
- CB101/8** (M8 fixing)
- CB101/10** (M10 fixing)
- CB101/12** (M12 fixing)

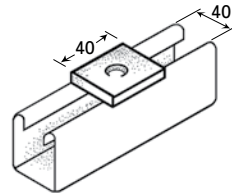

CB101/(size)

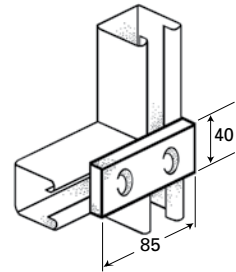

CB102

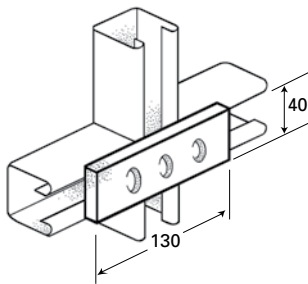

CB103

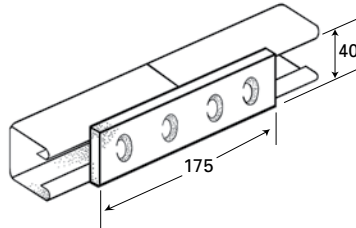

CB104

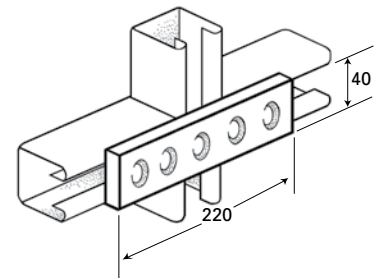

CB105

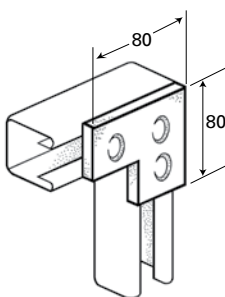

CB107

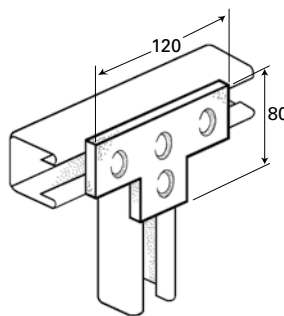

CB108

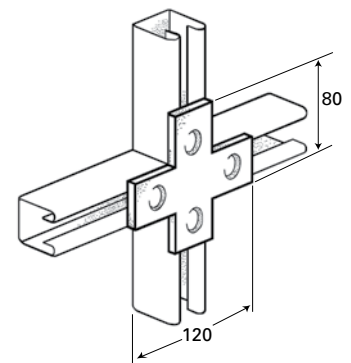

CB109

CHANNEL SUPPORT SYSTEMS

Right Angle Brackets

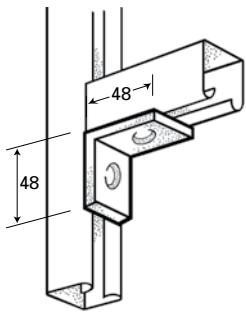

CB201

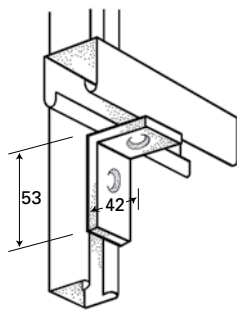

CB202

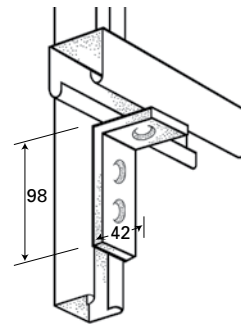

CB203

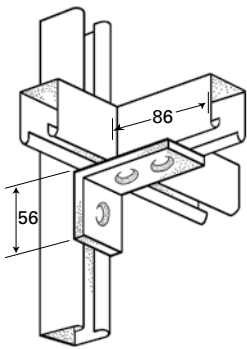

CB204

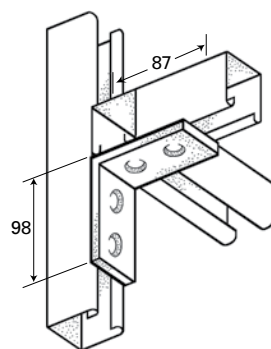

CB205

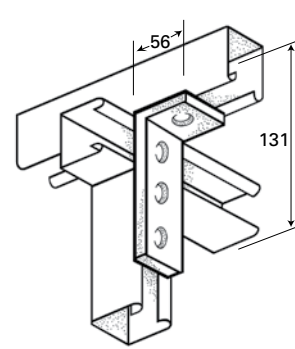

CB206

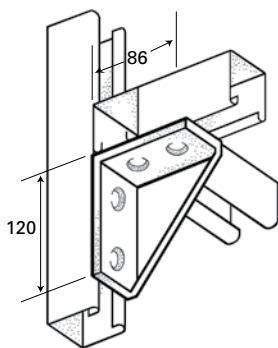

CB207

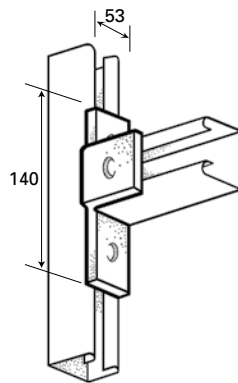

CB209

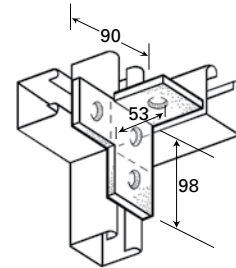

CB210

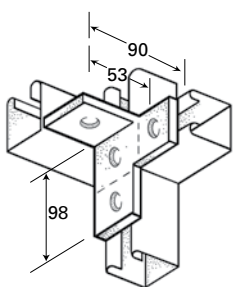

CB211

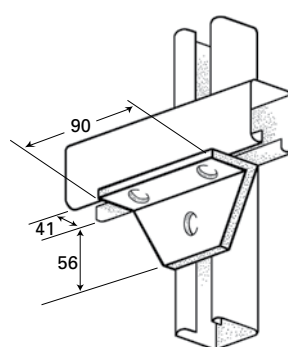

CB214

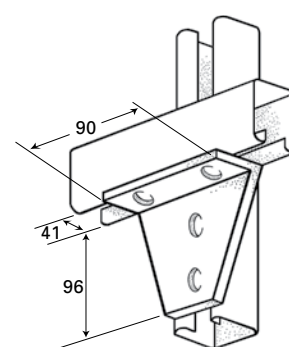



CB215

CHANNEL SUPPORT SYSTEMS

Z Brackets

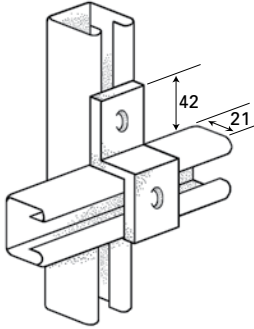
CB301 Shallow Channel 



CB302 Deep Channel 

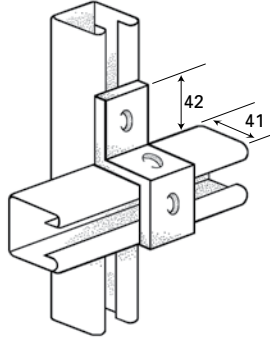

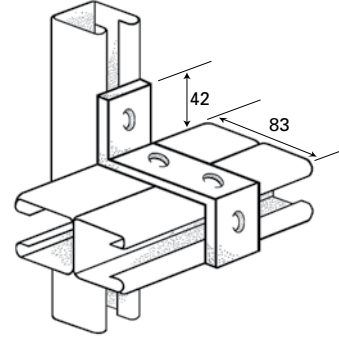

CB303 Back to Back 



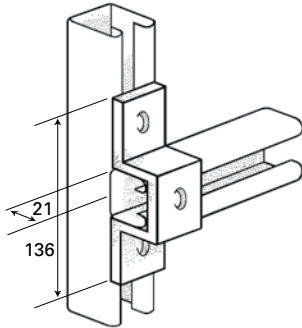

U Brackets

CB401 Shallow Channel 

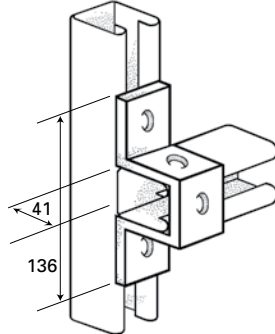

CB402 Deep Channel 



CB403 Back to Back 

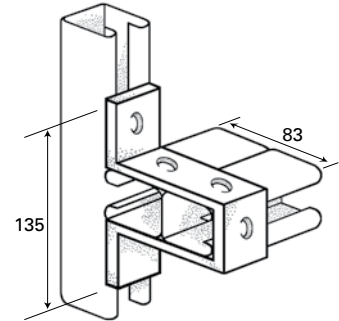

Holes on one side of bracket only

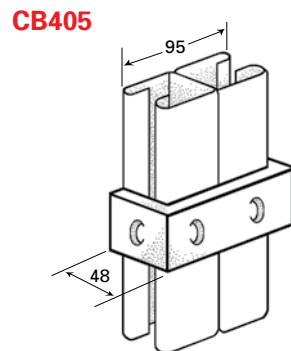
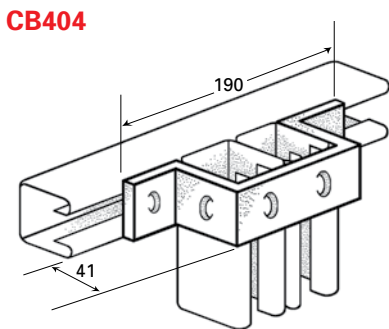

CHANNEL SUPPORT SYSTEMS

Angled Brackets

CB501

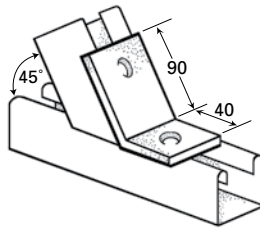

CB503

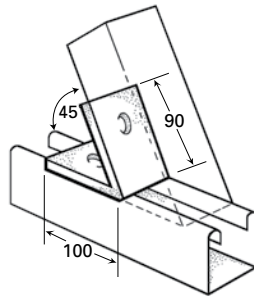

CB504

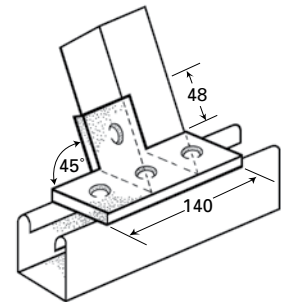

External Jointing Channel

CB603

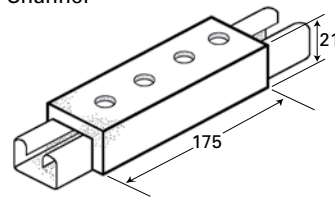

CB604

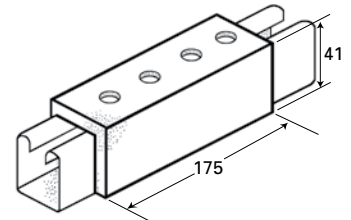
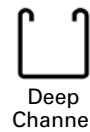

Internal Jointing Channel

Galvanised to BS EN 10346.

CB605/21

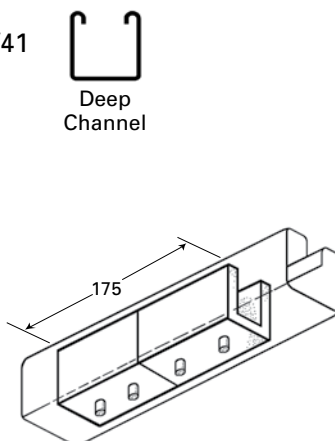

CB605/41

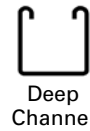

CB606/21

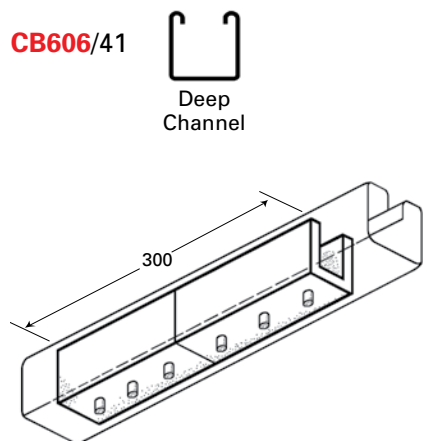

CB606/41



CHANNEL SUPPORT SYSTEMS

Base Plates

CB701

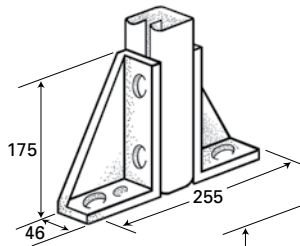
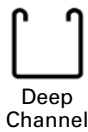

CB702

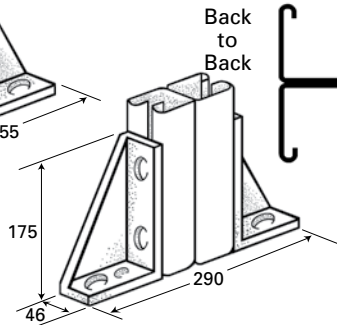

CB706

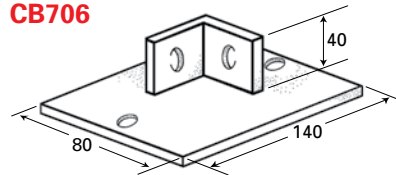

CB707

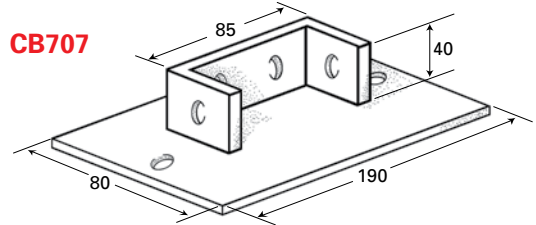

Wing Bracket

CB803

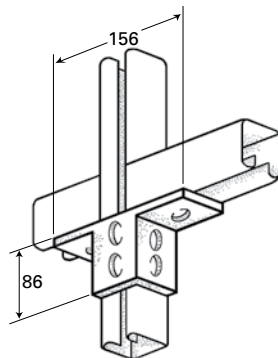

Beam Clamps

Must be used in pairs.
Cone point supplied.

CB901

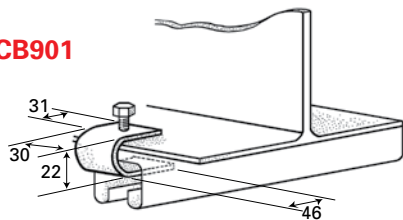

CB902

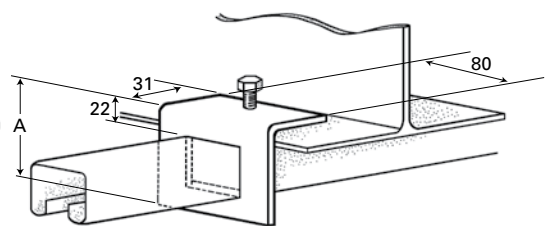
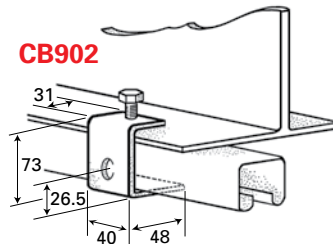

CB903/21 Shallow A = 66mm

CB903/41 Deep & Shallow Back to Back
A = 84mm

CB903/82 Deep Back to Back A = 134mm

CB904

Deep, Shallow &
Shallow Back to Back

CB905

Deep Back to Back
Must be used in pairs.
U Bolt nuts and washers
supplied.

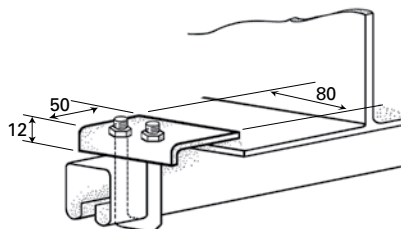

CB906

Must be used in pairs.
Cone point supplied.

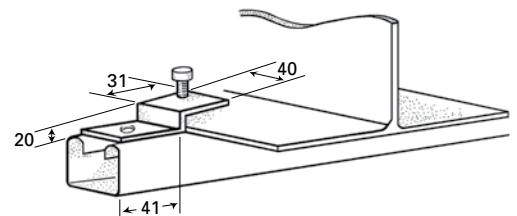

CB907

Must be used in pairs.
Set screw and channel
nut required.
Please order separately.

