



**PHILIP GRAHAME**

Member of  **NIEDAX GROUP**

# CABLE CONTAINMENT SYSTEMS

CABLE TRUNKING • CABLE TRAY • BASKET TRAY • CABLE LADDER • CHANNEL SUPPORTS

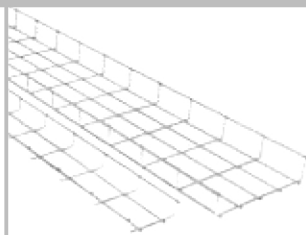



Established in 1982 as a supplier of electrical products to the Middle and Far East markets Philip Grahame International developed into a manufacturing company specialising in the cable containment sector of the electrical industry. Continual investment in the latest machinery, technology and distribution has resulted in the ability to provide a quality product at the most competitive price with an enviable reputation for service.

We supply direct to all of the major electrical contractors as well as medium to small independent contractors. Our overseas markets are served by established local agents in each country. Our project profile includes data centres, commercial buildings, sporting stadiums, industrial buildings, schools, hospitals etc.



### PRODUCT DEVELOPMENT & TESTING

Continuous improvement of existing products and innovative development of new products allows us to offer a comprehensive range of cable containment products. Investment in the latest solid modeling software and 3D printing speed up this process.

We participate extensively in national and international standardisation committees. All products are tested to the latest relevant standards.



### MANUFACTURING FACILITY

At our modern state of the art manufacturing facility in Chelmsford, Essex continual investment in CNC fully automated machinery and IT infrastructure has allowed us to produce quality products in a lean manufacturing environment.

The complete manufacturing facility is controlled by BS EN ISO 9001 quality processes within a BS EN ISO 14001 Environmental management System.



### STOCK & DISTRIBUTION

Our FORS Silver Accredited fleet of vehicles are the latest Euro classification allowing entry into inner-city low emission zones. Equipped with satellite tracking, full camera and side scan systems we are committed to managing our work related road risk (WRRR).

This in-house approach to stock holding and distribution ensures reliable deliveries, reduces Health & Safety issues associated with un-loading and facilitates environmental data collections.

# INDEX

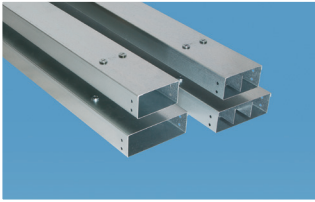

## STANDARD TRUNKING 5 - 12

Standard Trunking .....	6	Oversize Accessories .....	11-12
Accessories .....	7-8		
Specials .....	9		
Oversize Standard Trunking .....	10		

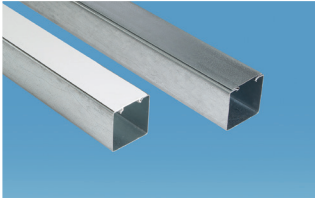

## LIGHTING TRUNKING 13 - 16

Clip-Lid Lighting Trunking .....	14		
Clip-Lid Cover .....	14		
Accessories .....	15-16		
Spares .....	16		

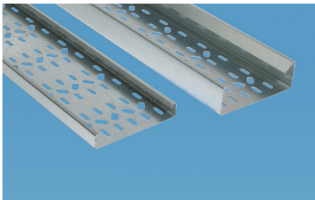

## CABLE TRAY 17 - 34

Medium Duty Return Flange Cable Tray .....	18-23	Standard Vertical Flange Cable Tray .....	30-33
Heavy Duty Return Flange Cable Tray .....	24-29	Accessories .....	34

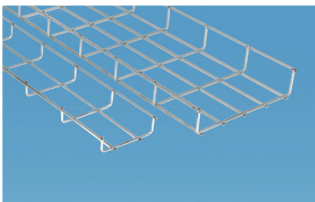

## BASKET TRAY 35 - 38

Medium Duty Basket Tray .....	36		
Heavy Duty Basket Tray .....	36		
Deep Heavy Duty Basket Tray .....	36		
Accessories .....	37-38		

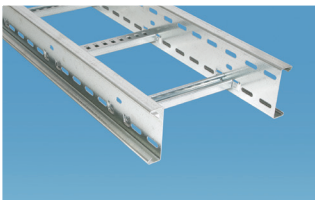

## CABLE LADDER 39 - 46

L4 - 100mm Sidewall .....	40		
L5 - 125mm Sidewall .....	40		
L6 - 150mm Sidewall .....	40		
Accessories .....	41-46		

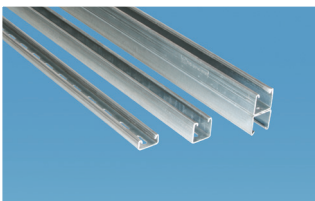

## CHANNEL SUPPORT SYSTEM 47 - 56

Standard Channels .....	48	Channel Nuts .....	51	Beam Clamps .....	56
Slotted Channels .....	48	Fittings & Brackets .....	52-55		
Supports .....	49	Base Plates .....	56		
Fixings .....	50	Wing Bracket .....	56		



FM 40329



EMS 59571



FORS ID 001729



REGISTERED MEMBER





# STANDARD TRUNKING



# STANDARD TRUNKING

## Standard Trunking

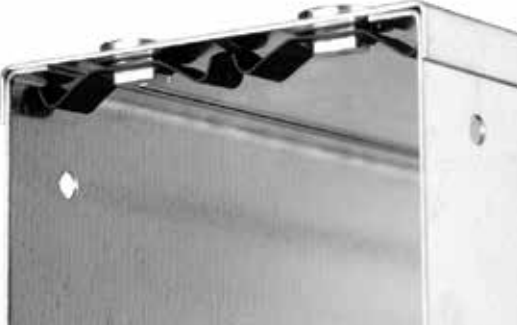

**British Standard** Complies with BS EN 50085

**FULL TECHNICAL SUBMITTAL AVAILABLE ON REQUEST**

**Standard Finish** Hot-Dip Pre-Galvanised to BS EN 10346

Code Suffix **/G**

**Special Finish** Epoxy Powder Coated Black/White

Code Suffix **/EP**

**Standard Length** 3.0 metres

Each length comprises of trunking body, trunking lid, 1 coupler, 8 x (M5 x 8 screw and nut).

Lid is secured by turnbuckle fasteners.

Earth continuity link must be ordered separately if required.

IP4X Length Cover Straps must be ordered separately for lengths only.

Accessories do not require cover straps.

Standard Trunking Lid is available to order separately.

Epoxy Powder Coated & Multi-Compartment Standard Trunking is made to order.

Trunking Size (mm) Width x Height	Product Code		
	1 Compartment	2 Compartment	3 Compartment
50 x 50	TL3/22		
75 x 50	TL3/32	TL3/32/2	
75 x 75	TL3/33	TL3/33/2	
100 x 50	TL3/42	TL3/42/2	
100 x 75	TL3/43	TL3/43/2	
100 x 100	TL3/44	TL3/44/2	
150 x 50	TL3/62	TL3/62/2	TL3/62/3
150 x 75	TL3/63	TL3/63/2	TL3/63/3
150 x 100	TL3/64	TL3/64/2	TL3/64/3
150 x 150	TL3/66	TL3/66/2	TL3/66/3

## Screw Fixed Trunking

- Screw fixed trunking is fastened using an M5 screw.
- Security screws Torx TR T25 are available to order separately.
- Screw fixed trunking is made to order.
- Specification is as per turnbuckle trunking.
- Order details - substitute T with S on all product codes.



# STANDARD TRUNKING

## Accessories

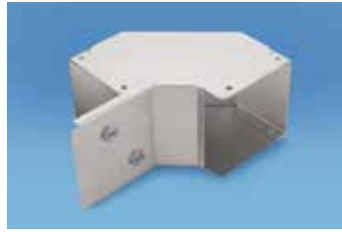
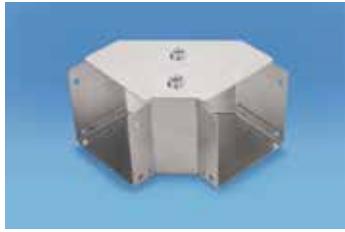

### Gusset Bends

**TB1**/(Size)  
Top Lid

**TB2**/(Size)  
Internal Lid

**TB3**/(Size)  
External Lid

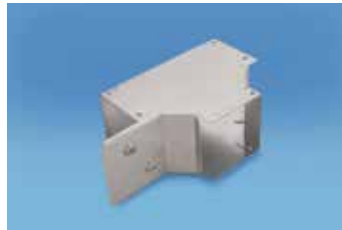

### Gusset Tees

**TT1**/(Size)  
Top Lid

**TT2**/(Size)  
Internal Lid

**TT3**/(Size)  
External Lid



### Elbow Bends

**TB1L**/(Size)  
Top Lid

**TB2L**/(Size)  
Internal Lid

**TB3L**/(Size)  
External Lid



### Elbow Tees

**TT1L**/(Size)  
Top Lid

**TT2L**/(Size)  
Internal Lid

**TT3L**/(Size)  
External Lid



### 45° Bends

**TH1**/(Size)  
Top Lid

**TH2**/(Size)  
Internal Lid

**TH3**/(Size)  
External Lid

**ORDERING DETAILS** - e.g. Gusset bend with top lid for 50 x 50mm trunking.  
Product Code TB1/+ Size 22 = TB1/22

Lid is available to order separately.

# STANDARD TRUNKING

## Accessories

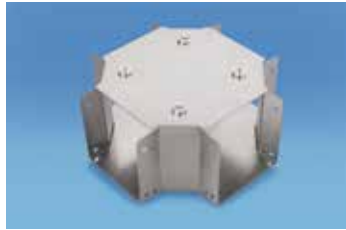

**TX/(Size)**  
4-Way Crosspiece



**TR/(Size)/(Size)**  
Reducer



**TCO/(Size)**  
Fitting Coupler



**TFTC/(Size)**  
Flanged Tee Connector

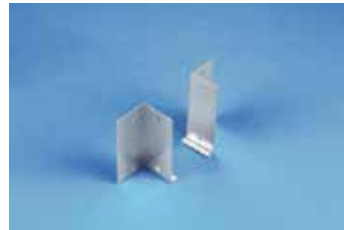

**TFC/(Height)**  
Flanged Connector

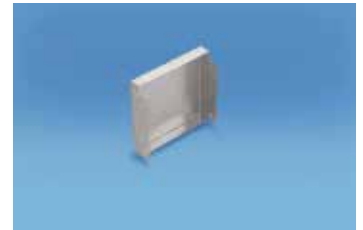

**TSE/(Size)**  
Stop End



**TSH/(Size)**  
Suspension Hanger  
(11mm hole)



**TSP/(Width)** Single Socket  
**TTP/(Width)** Twin Socket  
Socket Plate

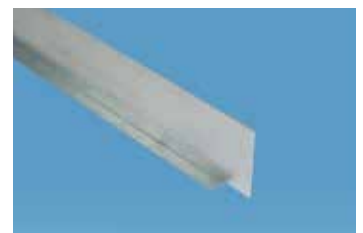

**TLDV3/(Height)**  
Loose Trunking Division



**TDS/(Width)**  
IP4X Length Cover Strap



**TCR/(Width)**  
Cable Retainer



**TPR/(Size)**  
Pin Rack

## Spares



**TEL100**  
Earth Link



**TSC/(Size)**  
Standard Coupler



**SFX100**  
Screw Fixed Lid Insert and Screw



**TFX100**  
Fixing Screws and Nuts



**TFU100**  
Turnbuckle Fastener Unit



**SMD400**  
Security Screw Torx TR T25



# STANDARD TRUNKING

## Specials

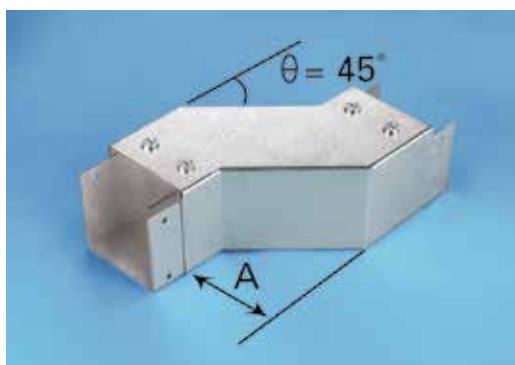

**THOR**/(Size)  
Horizontal Offset (right hand)

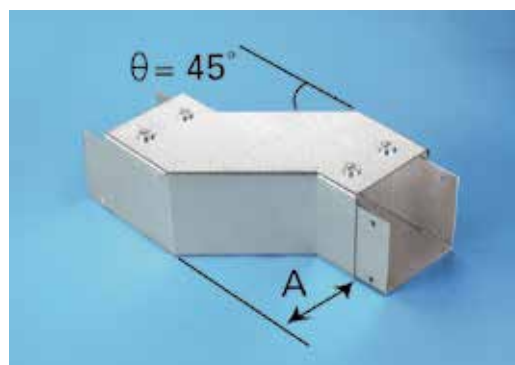

**THOL**/(Size)  
Horizontal Offset (left hand)

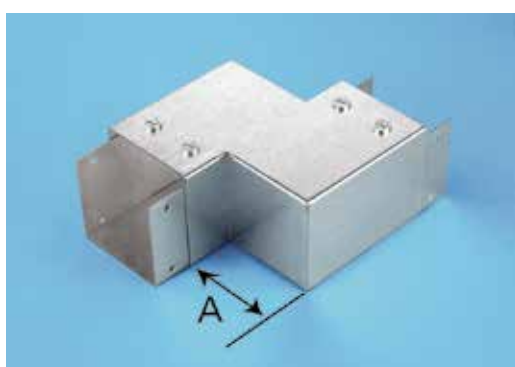

**THAR**/(Size)  
Horizontal Angled Offset (right hand)

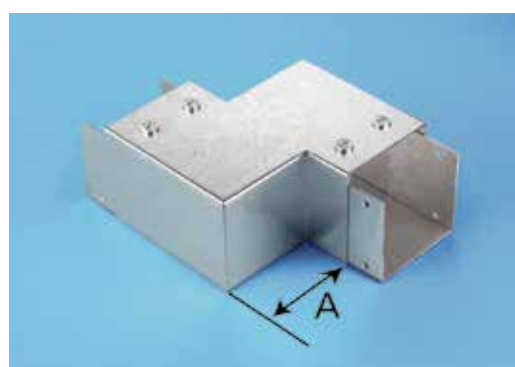

**THAL**/(Size)  
Horizontal Angled Offset (left hand)



**TVO**/(Size)  
Vertical Offset

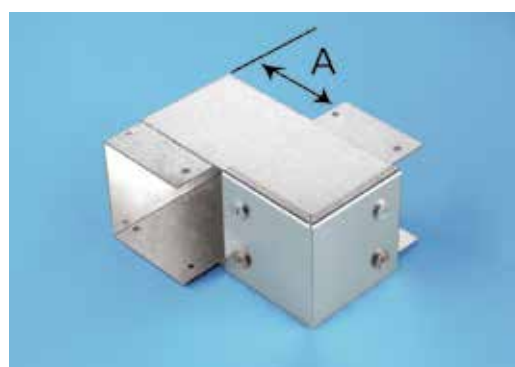

**TVA**/(Size)  
Vertical Angle Offset

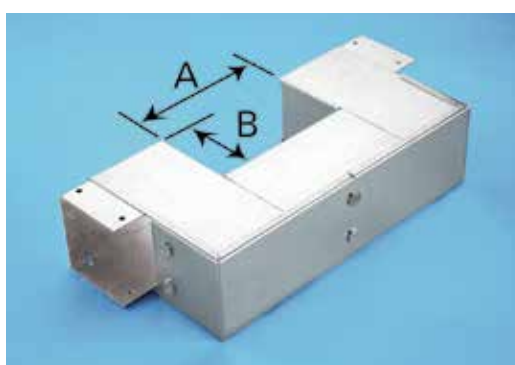

**TPS**/(Size)  
Pier Set

Please state dimension A  
when ordering.  
Please state dimensions A and B  
for Pier Set.

# STANDARD TRUNKING

## Oversize Standard Trunking

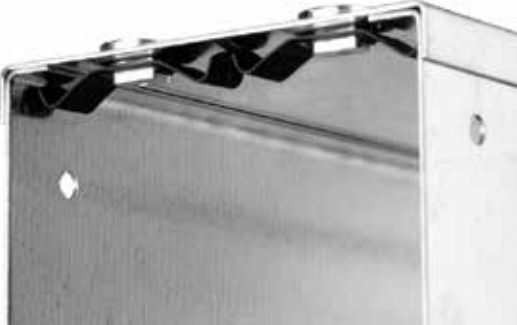

**British Standard** Complies with BS EN 50085

**FULL TECHNICAL SUBMITTAL AVAILABLE ON REQUEST**

**Standard Finish** Hot-Dip Pre-Galvanised to BS EN 10346

Code Suffix **/G**

**Special Finish** Epoxy Powder Coated Black/White

Code Suffix **/EP**

**Standard Length** 3.0 metres

All Oversized Trunking is made to order.

Each length comprises of trunking body, 2x1.5m trunking lids, 1 coupler, 8 x (M5 x 8 screw and nut).

Lid is secured by turnbuckle fasteners.

Earth continuity link must be ordered separately if required.

IP4X Length Cover Straps must be ordered separately for lengths only.

Accessories do not require cover straps.

Oversize Trunking Lid is available to order separately.

Trunking Size (mm) Width x Height	Product Code			
	1 Compartment	2 Compartment	3 Compartment	4 Compartment
200 x 50	TL3/82	TL3/82/2	TL3/82/3	TL3/82/4
200 x 75	TL3/83	TL3/83/2	TL3/83/3	TL3/83/4
200 x 100	TL3/84	TL3/84/2	TL3/84/3	TL3/84/4
200 x 150	TL3/86	TL3/86/2	TL3/86/3	TL3/86/4
200 x 200	TL3/88	TL3/88/2	TL3/88/3	TL3/88/4
225 x 50	TL3/92	TL3/92/2	TL3/92/3	TL3/92/4
225 x 75	TL3/93	TL3/93/2	TL3/93/3	TL3/93/4
225 x 100	TL3/94	TL3/94/2	TL3/94/3	TL3/94/4
225 x 150	TL3/96	TL3/96/2	TL3/96/3	TL3/96/4
225 x 200	TL3/98	TL3/98/2	TL3/98/3	TL3/98/4
225 x 225	TL3/99	TL3/99/2	TL3/99/3	TL3/99/4
300 x 50	TL3/122	TL3/122/2	TL3/122/3	TL3/122/4
300 x 75	TL3/123	TL3/123/2	TL3/123/3	TL3/123/4
300 x 100	TL3/124	TL3/124/2	TL3/124/3	TL3/124/4
300 x 150	TL3/126	TL3/126/2	TL3/126/3	TL3/126/4
300 x 200	TL3/128	TL3/128/2	TL3/128/3	TL3/128/4
300 x 225	TL3/129	TL3/129/2	TL3/129/3	TL3/129/4
300 x 300	TL3/1212			

## Screw Fixed Trunking

- Screw fixed trunking is fastened using an M5 screw.
- Security screws Torx TR T25 are available to order separately.
- Screw fixed trunking is made to order.
- Specification is as per turnbuckle trunking.
- Order details - substitute T with S on all product codes.



# STANDARD TRUNKING

## Oversize Accessories

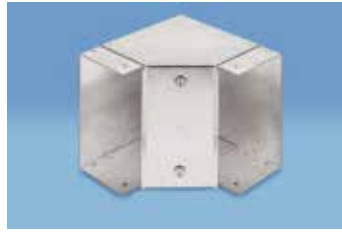
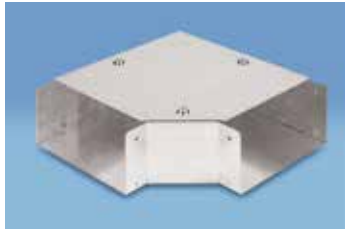

### Gusset Bends

**TB1**/(Size)  
Top Lid

**TB2**/(Size)  
Internal Lid

**TB3**/(Size)  
External Lid



### Gusset Tees

**TT1**/(Size)  
Top Lid

**TT2**/(Size)  
Internal Lid

**TT3**/(Size)  
External Lid

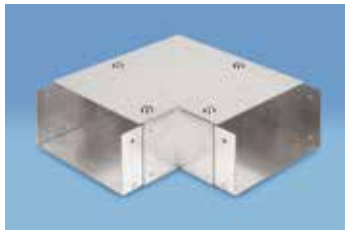

### Elbow Bends

**TB1L**/(Size)  
Top Lid

**TB2L**/(Size)  
Internal Lid

**TB3L**/(Size)  
External Lid

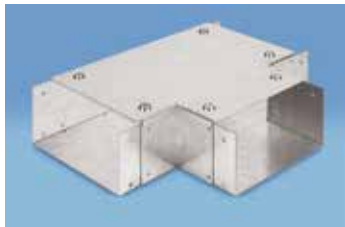

### Elbow Tees

**TT1L**/(Size)  
Top Lid

**TT2L**/(Size)  
Internal Lid

**TT3L**/(Size)  
External Lid



### 45° Bends

**TH1**/(Size)  
Top Lid

**TH2**/(Size)  
Internal Lid

**TH3**/(Size)  
External Lid

**ORDERING DETAILS** - e.g. Gusset bend with top lid for 200 x 50mm trunking.  
Product Code TB1/+ Size 82 = TB1/82

Lid is available to order separately.

# STANDARD TRUNKING

## Accessories

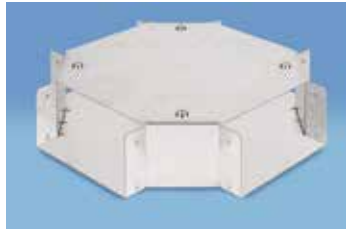

**TX/(Size)**  
4-Way Crosspiece



**TR/(Size)/(Size)**  
Reducer



**TCO/(Size)**  
Fitting Coupler



**TFTC/(Size)**  
Flanged Tee Connector

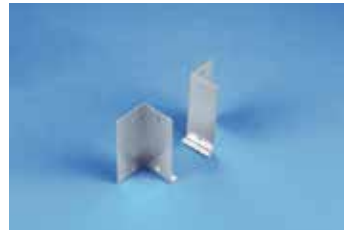

**TFC/(Height)**  
Flanged Connector



**TSE/(Size)**  
Stop End



**TSH/(Size)**  
Suspension Hanger  
(11mm hole)

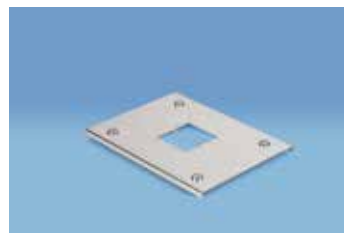

**TSP/(Width) Single Socket**  
**TTP/(Width) Twin Socket**  
Socket Plate

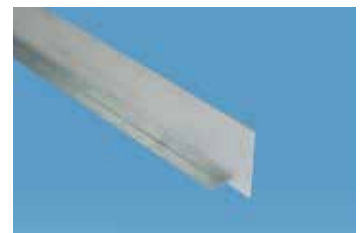

**TLDV3/(Height)**  
Loose Trunking Division



**TDS/(Width)**  
IP4X Length Cover Strap



**TCR/(Width)**  
Cable Retainer



**TPR/(Size)**  
Pin Rack

## Spares



**TEL100**  
Earth Link



**TSC/(Size)**  
Standard Coupler



**SFX100**  
Screw Fixed Lid Insert and Screw



**TFX100**  
Fixing Screws and Nuts



**TFU100**  
Turnbuckle Fastener Unit



**SMD400**  
Security Screw Torx TR T25



# LIGHTING TRUNKING



# LIGHTING TRUNKING

## Clip-lid Lighting Trunking

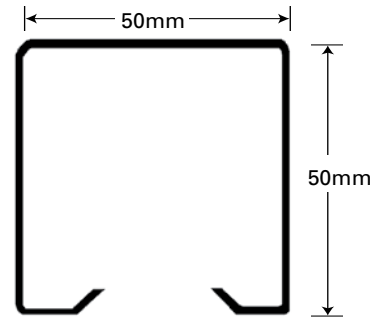

Product Code **LT/22**

		Code Suffix
<b>BRITISH STANDARD</b>	Complies with BS EN 50085	
<b>STANDARD LENGTH</b>	5.0 metres	
<b>FULL TECHNICAL SUBMITTAL AVAILABLE ON REQUEST</b>		
<b>STANDARD FINISH</b>	Hot-Dip Pre-Galvanised to BS EN 10346	<b>/G</b>
<b>SPECIAL FINISH</b>	Epoxy Powder Coated White	<b>/EP</b>

## Clip-lid Cover

All lids supplied in 4m lengths

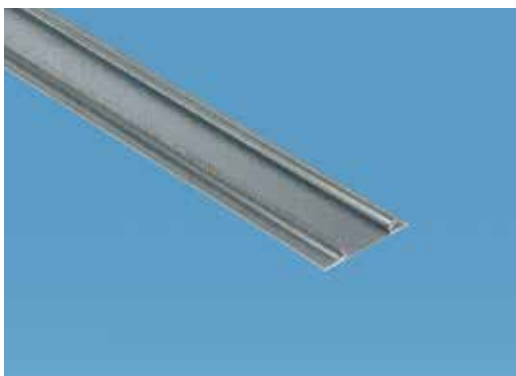

Product Code  
**LSL/2/G**

Galvanised Steel



Product Code  
**LPL/2/PVC**

White PVC

## Accessories



**LB1/22**  
90° Flat Bend



**LB2/22**  
90° Inside Bend



**LB3/22**  
90° Outside Bend



**LH1/22**  
45° Flat Bend

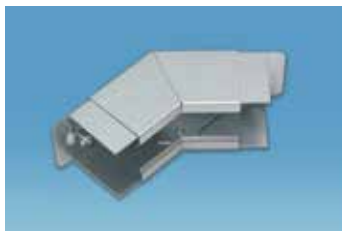

**LH2/22**  
45° Inside Bend

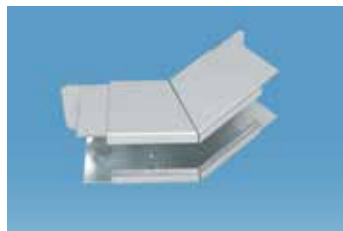

**LH3/22**  
45° Outside Bend



**LT1/22**  
Flat Tee



**LX/22**  
4-Way Crosspiece



**LSE/22**  
Stop End

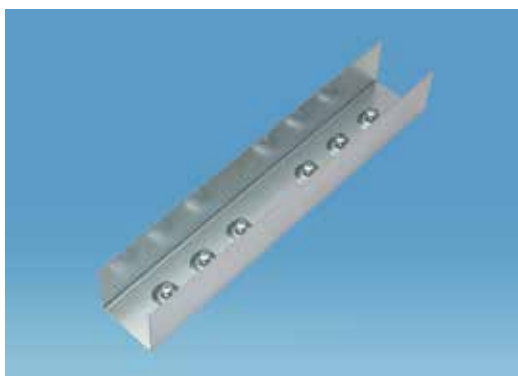

**LLC/22**  
Coupler (300mm long)

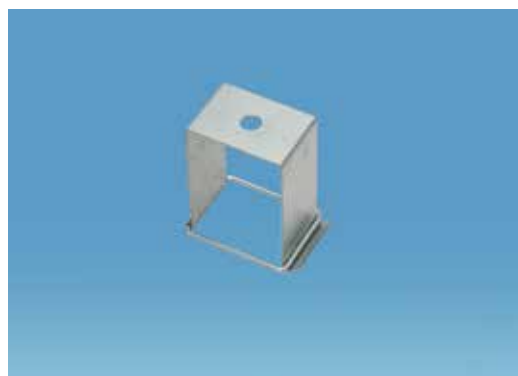

**LSB10/22**  
Hanger Bracket  
with 11mm diameter hole

**LSB20/22**  
Hanger Bracket  
with 20mm diameter hole

# LIGHTING TRUNKING

## Accessories

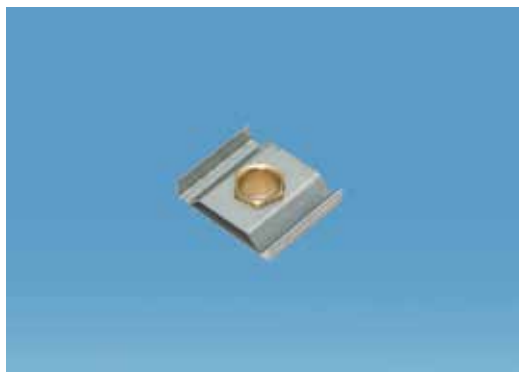

**LLS100**  
Lighting Fitting Suspension Unit



**LFC/22**  
Flanged Connector



**LBC/22**  
Beam Clamp



**KLK/100**  
KLIK Socket Adaptor

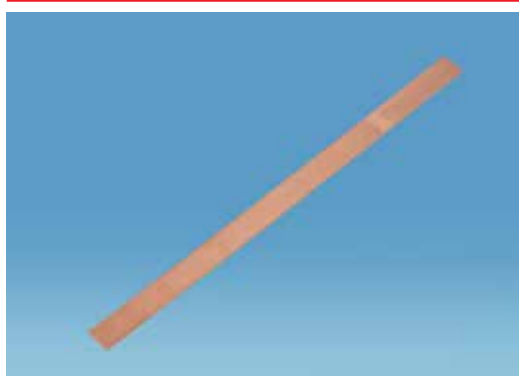

**LEL100**  
Earth Strap (positions under coupler)



**LCR/2**  
Cable Retainer

## Spares



**LFX100**  
M5 x 8 Fixing Screws





# CABLE TRAY

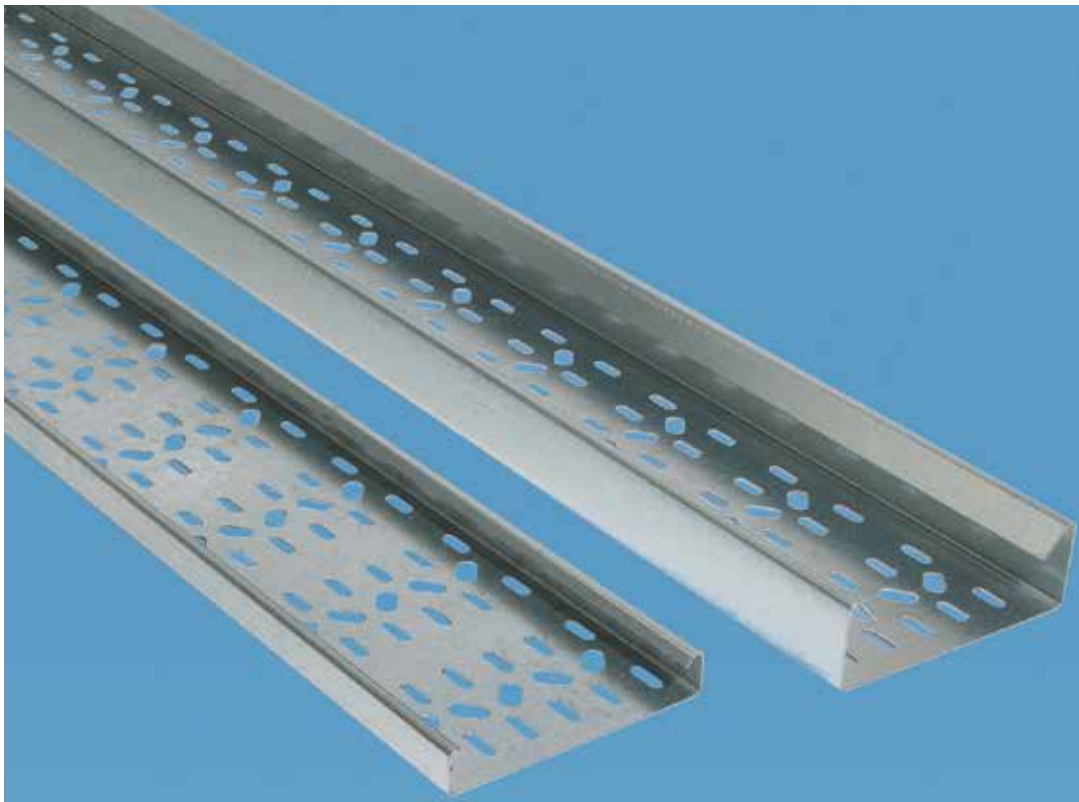

# CABLE TRAY

## Medium Duty Return Flange Cable Tray

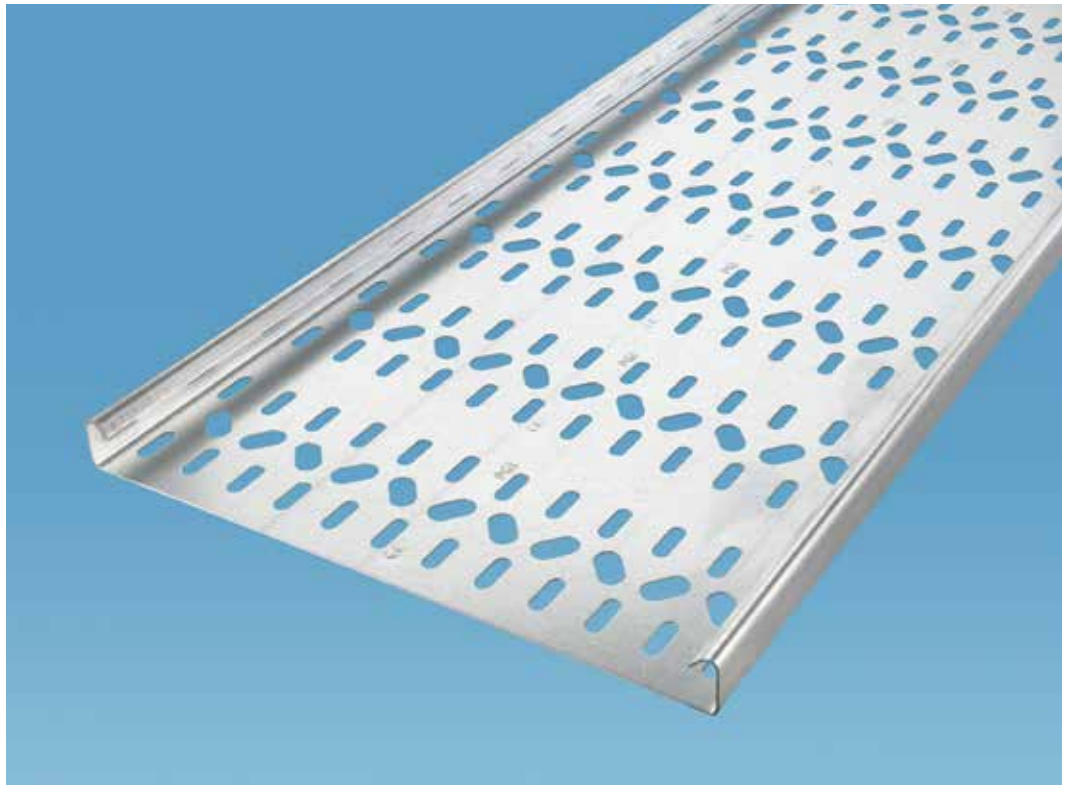

---

### Flange Profile



---

### Unique Slot Pattern

Cable clamps can be attached to the larger 20 x 11 slots using up to M10 fixings without drilling.

Longitudinal running 20 x 7 slots permit use of cable ties up to 20mm wide, correctly positioned across the width of the tray instead of staggered as with conventional patterns.

The tray length may be cut at any position along the 3 metre axis and can still be connected to any fitting or adjoining length without drilling.

# CABLE TRAY

## Tray Lengths

Product Code	Tray Width (mm)	Flange Height (mm)
MRL/50	50	25
MRL/75	75	25
MRL/100	100	25
MRL/150	150	25
MRL/225	225	25
MRL/300	300	25
MRL/450	450	25
MRL/600	600	25
MRL/750	750	25
MRL/900	900	25

All 750 & 900mm Tray Lengths & Fittings are made to order.

		Code Suffix
<b>BRITISH STANDARD</b>	Complies with BS EN 61537	
<b>FULL TECHNICAL SUBMITTAL AVAILABLE ON REQUEST</b>		
<b>STANDARD LENGTH</b>	3.0 metres	
<b>STANDARD FINISH</b>	Hot-Dip Pre-Galvanised to BS EN 10346	<b>/G</b>
<b>SPECIAL FINISH</b>	Epoxy Powder Coated Black/White	<b>/EP</b>

## Cable Tray Division

**STANDARD LENGTH** 3.0 metres

Made to Order



Product Code **MRDV**

## Cable Tray Covers

**STANDARD LENGTH** 1.5 metres

Covers are available for the complete range, including fittings.

Add C to the start of the Product Code.

Supplied complete with fixings.

Made to Order



Product Code **CMRL**

# CABLE TRAY

## Coupler

Product Code **MRC**

Outside Couplers are supplied in pairs and should be ordered separately for each length of tray as required.



## Cranked Coupler

Product Code **MRCC**

Outside Cranked Couplers are supplied in pairs with the correct number being supplied with each tray fitting.

(Also available as separate items.)



## 90° Flat Bend

Product Code **MRB**

Width (mm)	Product Code 90°
50	MRB/50/90
75	MRB/75/90
100	MRB/100/90
150	MRB/150/90
225	MRB/225/90
300	MRB/300/90
450	MRB/450/90
600	MRB/600/90
750	MRB/750/90
900	MRB/900/90

Flat Bend supplied with 2 x MRCC

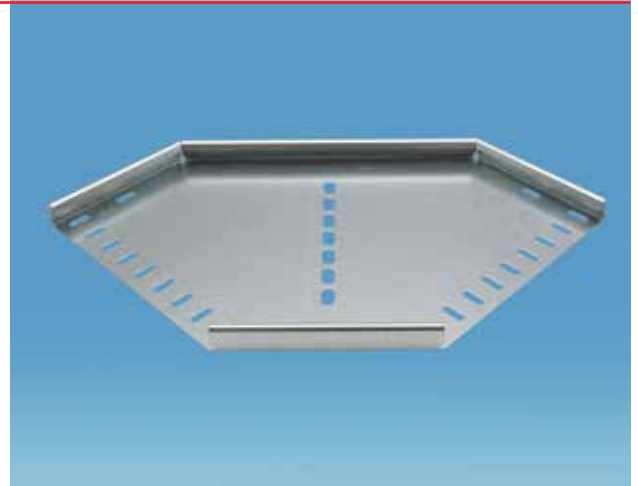

## Flat Bend

Product Code **MRB**

Width (mm)	Product Code		
	30°	45°	60°
50	MRB/50/30	MRB/50/45	MRB/50/60
75	MRB/75/30	MRB/75/45	MRB/75/60
100	MRB/100/30	MRB/100/45	MRB/100/60
150	MRB/150/30	MRB/150/45	MRB/150/60
225	MRB/225/30	MRB/225/45	MRB/225/60
300	MRB/300/30	MRB/300/45	MRB/300/60
450	MRB/450/30	MRB/450/45	MRB/450/60
600	MRB/600/30	MRB/600/45	MRB/600/60
750	MRB/750/30	MRB/750/45	MRB/750/60
900	MRB/900/30	MRB/900/45	MRB/900/60

Flat Bend supplied with 2 x MRCC

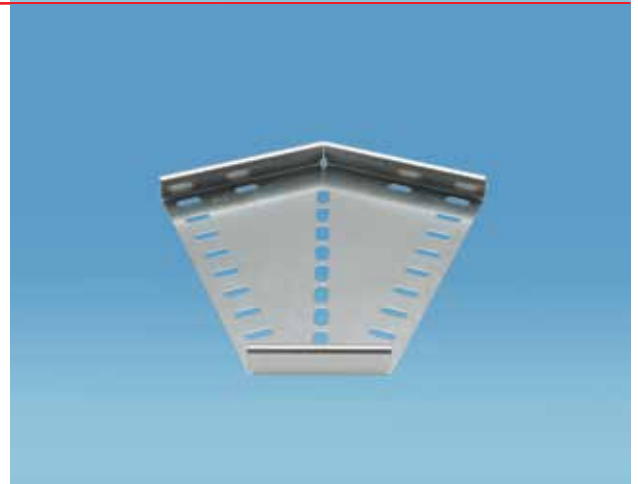

30° & 60° Flat Bends are Made to Order

# CABLE TRAY

## Equal Tee

Product Code **MRT**

Width (mm)	Product Code
50	MRT/50
75	MRT/75
100	MRT/100
150	MRT/150
225	MRT/225
300	MRT/300
450	MRT/450
600	MRT/600
750	MRT/750
900	MRT/900

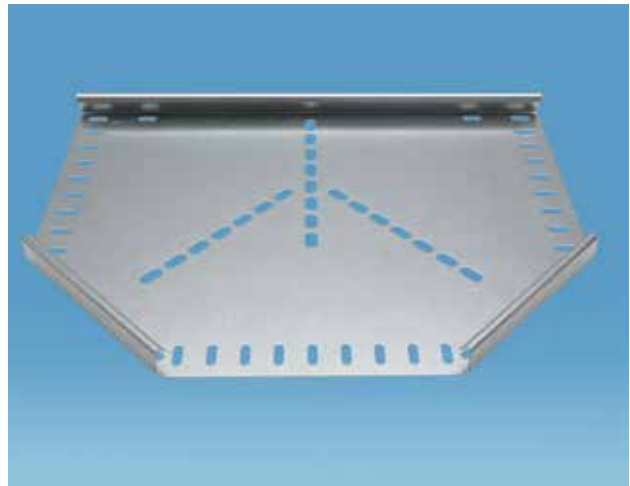

Equal Tee  
supplied with  
4 x MRCC

## Unequal Tee

Product Code **MRUT**

PLEASE STATE A AND B TRAY WIDTHS WHEN ORDERING

Made to Order

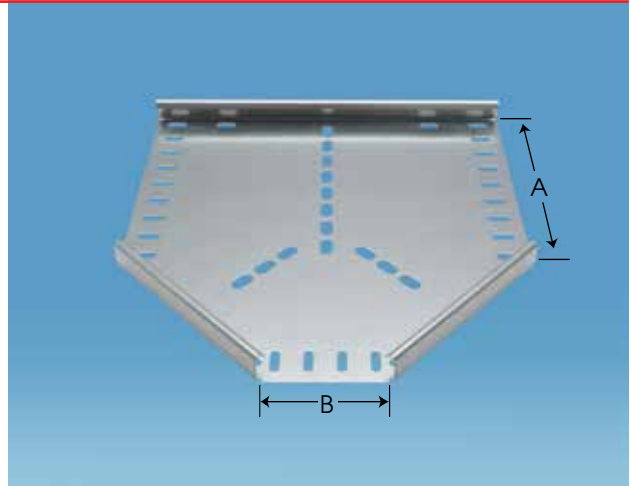

Unequal Tee  
supplied with  
4 x MRCC

## Inside Riser

Product Code **MRIR**

Width (mm)	Product Code	
	90°	45°
50	MRIR/50/90	MRIR/50/45
75	MRIR/75/90	MRIR/75/45
100	MRIR/100/90	MRIR/100/45
150	MRIR/150/90	MRIR/150/45
225	MRIR/225/90	MRIR/225/45
300	MRIR/300/90	MRIR/300/45
450	MRIR/450/90	MRIR/450/45
600	MRIR/600/90	MRIR/600/45
750	MRIR/750/90	MRIR/750/45
900	MRIR/900/90	MRIR/900/45

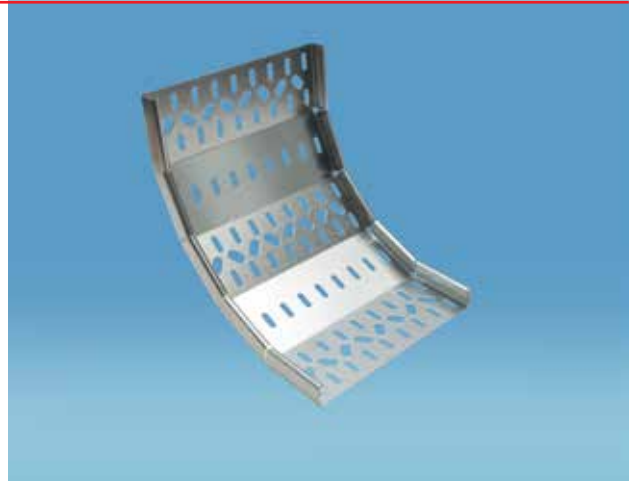

Inside Riser  
supplied with  
2 x MRC

## Outside Riser

Product Code **MROR**

Width (mm)	Product Code	
	90°	45°
50	MROR/50/90	MROR/50/45
75	MROR/75/90	MROR/75/45
100	MROR/100/90	MROR/100/45
150	MROR/150/90	MROR/150/45
225	MROR/225/90	MROR/225/45
300	MROR/300/90	MROR/300/45
450	MROR/450/90	MROR/450/45
600	MROR/600/90	MROR/600/45
750	MROR/750/90	MROR/750/45
900	MROR/900/90	MROR/900/45

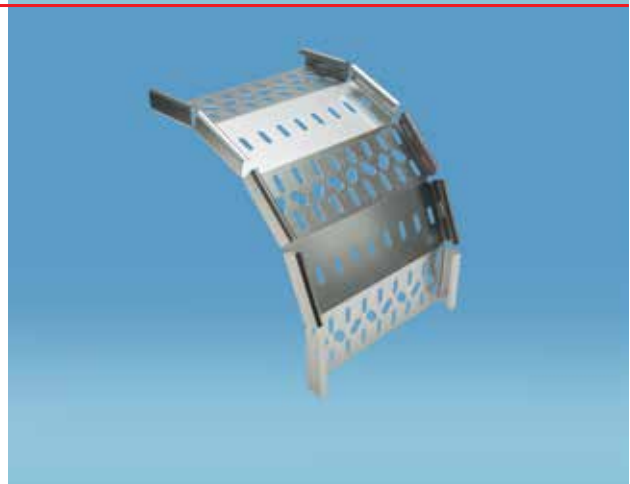

Outside Riser  
supplied with  
2 x MRC

# CABLE TRAY

## 4-Way Crosspiece

Product Code **MRX**

Width (mm)	Product Code
50	MRX/50
75	MRX/75
100	MRX/100
150	MRX/150
225	MRX/225
300	MRX/300
450	MRX/450
600	MRX/600
750	MRX/750
900	MRX/900

4-Way Crosspiece supplied with 8 x MRCC

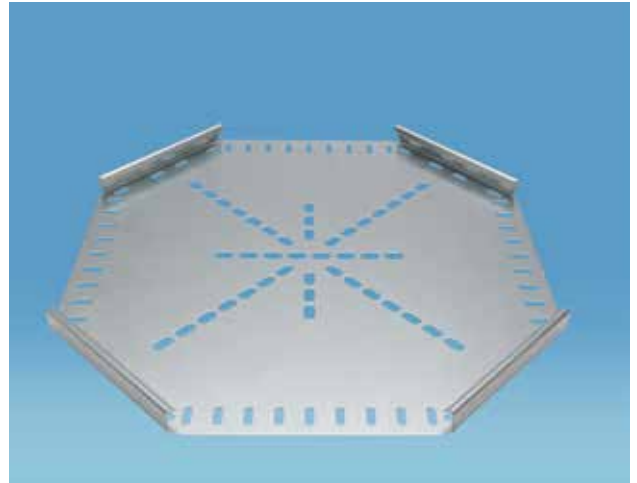

## Reducer

Product Code **MRR**

Width 'B'	Width 'A'								
	75	100	150	225	300	450	600	750	900
50	MRR/75/50	MRR/100/50	MRR/150/50	MRR/225/50	MRR/300/50	MRR/450/50	MRR/600/50	MRR/750/50	MRR/900/50
75	-	MRR/100/75	MRR/150/75	MRR/225/75	MRR/300/75	MRR/450/75	MRR/600/75	MRR/750/75	MRR/900/75
100	-	-	MRR/150/100	MRR/225/100	MRR/300/100	MRR/450/100	MRR/600/100	MRR/750/100	MRR/900/100
150	-	-	-	MRR/225/150	MRR/300/150	MRR/450/150	MRR/600/150	MRR/750/150	MRR/900/150
225	-	-	-	-	MRR/300/225	MRR/450/225	MRR/600/225	MRR/750/225	MRR/900/225
300	-	-	-	-	-	MRR/450/300	MRR/600/300	MRR/750/300	MRR/900/300
450	-	-	-	-	-	-	MRR/600/450	MRR/750/450	MRR/900/450
600	-	-	-	-	-	-	-	MRR/750/600	MRR/900/600
750	-	-	-	-	-	-	-	-	MRR/900/750

Reducer supplied with 2x MRCC

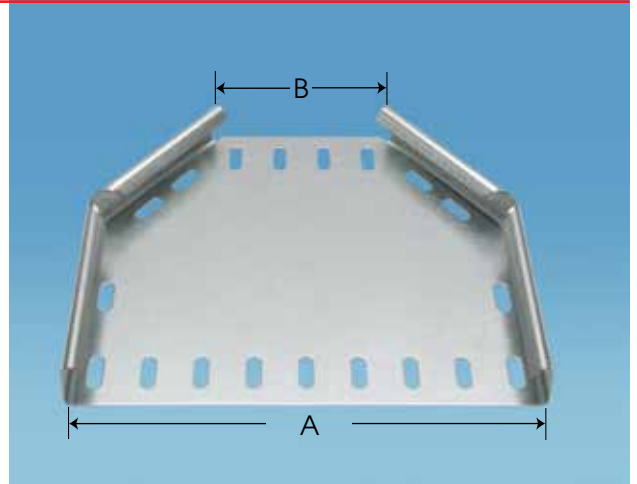

## Offset Reducer - Left Hand

Product Code **MRLR**

Width 'B'	Width 'A'								
	75	100	150	225	300	450	600	750	900
50	MRLR/75/50	MRLR/100/50	MRLR/150/50	MRLR/225/50	MRLR/300/50	MRLR/450/50	MRLR/600/50	MRLR/750/50	MRLR/900/50
75	-	MRLR/100/75	MRLR/150/75	MRLR/225/75	MRLR/300/75	MRLR/450/75	MRLR/600/75	MRLR/750/75	MRLR/900/75
100	-	-	MRLR/150/100	MRLR/225/100	MRLR/300/100	MRLR/450/100	MRLR/600/100	MRLR/750/100	MRLR/900/100
150	-	-	-	MRLR/225/150	MRLR/300/150	MRLR/450/150	MRLR/600/150	MRLR/750/150	MRLR/900/150
225	-	-	-	-	MRLR/300/225	MRLR/450/225	MRLR/600/225	MRLR/750/225	MRLR/900/225
300	-	-	-	-	-	MRLR/450/300	MRLR/600/300	MRLR/750/300	MRLR/900/300
450	-	-	-	-	-	-	MRLR/600/450	MRLR/750/450	MRLR/900/450
600	-	-	-	-	-	-	-	MRLR/750/600	MRLR/900/600
750	-	-	-	-	-	-	-	-	MRLR/900/750

Made to Order

Reducer supplied with 2x MRCC

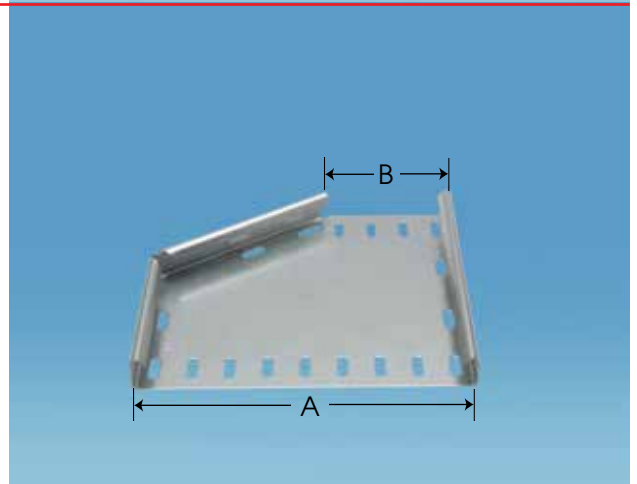

## Offset Reducer - Right Hand

Product Code **MRRR**

Width 'B'	Width 'A'								
	75	100	150	225	300	450	600	750	900
50	MRRR/75/50	MRRR/100/50	MRRR/150/50	MRRR/225/50	MRRR/300/50	MRRR/450/50	MRRR/600/50	MRRR/750/50	MRRR/900/50
75	-	MRRR/100/75	MRRR/150/75	MRRR/225/75	MRRR/300/75	MRRR/450/75	MRRR/600/75	MRRR/750/75	MRRR/900/75
100	-	-	MRRR/150/100	MRRR/225/100	MRRR/300/100	MRRR/450/100	MRRR/600/100	MRRR/750/100	MRRR/900/100
150	-	-	-	MRRR/225/150	MRRR/300/150	MRRR/450/150	MRRR/600/150	MRRR/750/150	MRRR/900/150
225	-	-	-	-	MRRR/300/225	MRRR/450/225	MRRR/600/225	MRRR/750/225	MRRR/900/225
300	-	-	-	-	-	MRRR/450/300	MRRR/600/300	MRRR/750/300	MRRR/900/300
450	-	-	-	-	-	-	MRRR/600/450	MRRR/750/450	MRRR/900/450
600	-	-	-	-	-	-	-	MRRR/750/600	MRRR/900/600
750	-	-	-	-	-	-	-	-	MRRR/900/750

Made to Order

Reducer supplied with 2 x MRCC

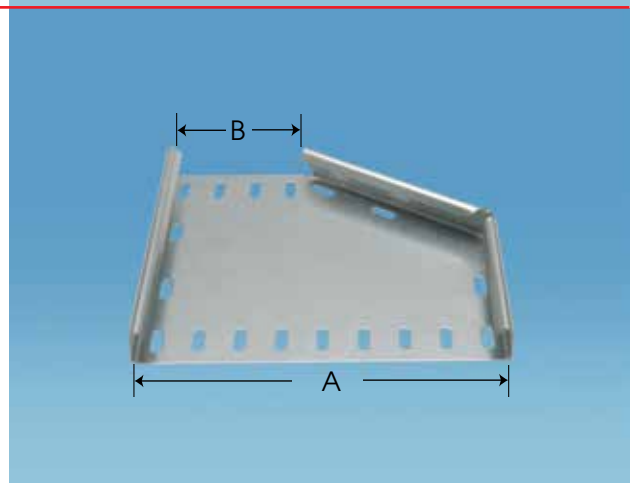

# CABLE TRAY ACCESSORIES

## Overhead Hanger

Product Code **OHH**

Width (mm)	Product Code
50	OHH/50
75	OHH/75
100	OHH/100
150	OHH/150
225	OHH/225
300	OHH/300



## Stand-off Bracket

Product Code **CA107**

Width (mm)	Product Code	Z mm
50	CA107/50	25
75	CA107/75	25
100	CA107/100	50
150	CA107/150	50
225	CA107/225	75
300	CA107/300	75
450	CA107/450	75
600	CA107/600	75
750	CA107/750	75
900	CA107/900	75

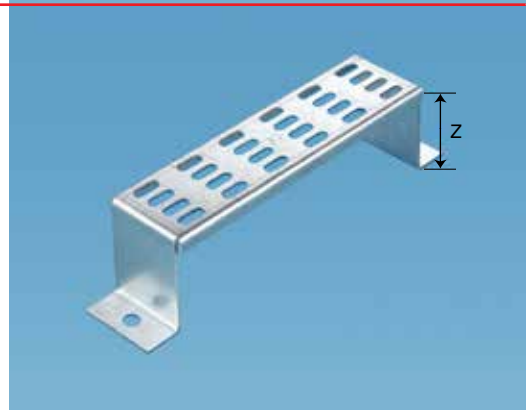

## Cantilever Arm

Product Code **CA106**

Width (mm)	Product Code
100	CA106/100
150	CA106/150
225	CA106/225
300	CA106/300
450	CA106/450
600	CA106/600
750	CA106/750
900	CA106/900



## Fishplate

Product Code **FPC**

Width (mm)	Product Code	A mm
150	FPC/150	75
225	FPC/225	150
300	FPC/300	225
450	FPC/450	375
600	FPC/600	525
750	FPC/750	675
900	FPC/900	825

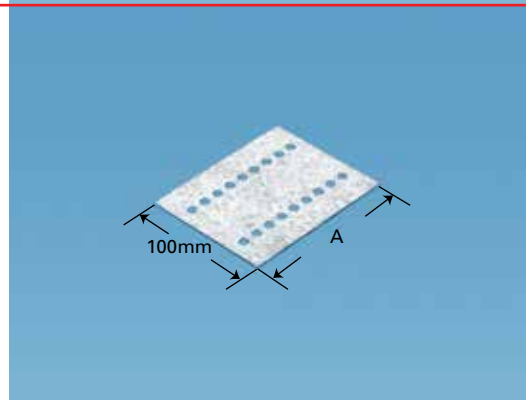

## Cover Bracket

Product Code **MR/BRK**



## Earth Continuity Connector

Product Code **TECC100**



## CABLE TRAY

### Heavy Duty Return Flange Cable Tray

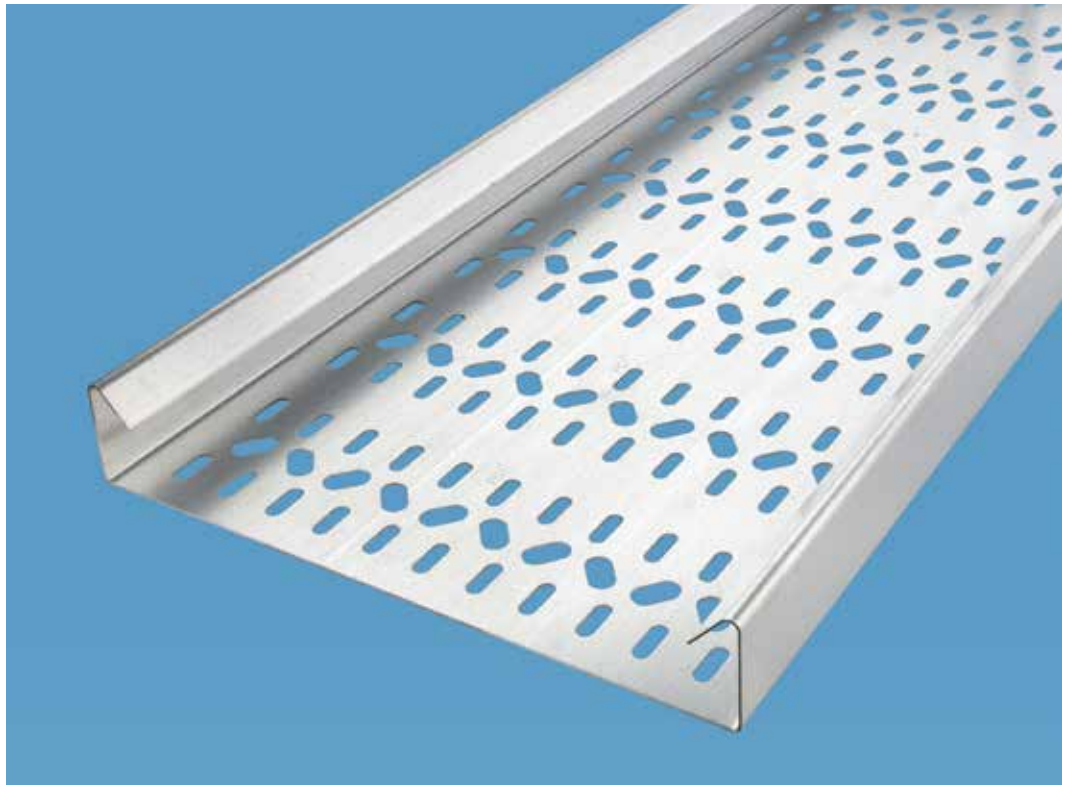

#### Flange Profile

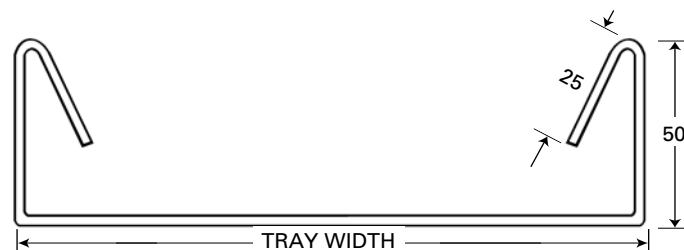

#### Unique Slot Pattern

Cable clamps can be attached to the larger 20 x 11 slots using up to M10 fixings without drilling.

Longitudinal running 20 x 7 slots permit use of cable ties up to 20mm wide, correctly positioned across the width of the tray instead of staggered as with conventional patterns.

The tray length may be cut at any position along the 3 metre axis and can still be connected to any fitting or adjoining length without drilling.



# CABLE TRAY

## Tray Lengths

Product Code	Tray Width (mm)	Flange Height (mm)
HRL/75	75	50
HRL/100	100	50
HRL/150	150	50
HRL/225	225	50
HRL/300	300	50
HRL/450	450	50
HRL/600	600	50
HRL/750	750	50
HRL/900	900	50

		Code Suffix
<b>BRITISH STANDARD</b>	Complies with BS EN 61537	
<b>FULL TECHNICAL SUBMITTAL AVAILABLE ON REQUEST</b>		
<b>STANDARD LENGTH</b>	3.0 metres	
<b>STANDARD FINISH</b>	Hot-Dip Pre-Galvanised to BS EN 10346	<b>/G</b>
<b>SPECIAL FINISH</b>	Epoxy Powder Coated Black/White	<b>/EP</b>

## Cable Tray Division

**STANDARD LENGTH** 3.0 metres

Made to Order



Product Code **HRDV**

## Cable Tray Covers

**STANDARD LENGTH** 1.5 metres

Covers are available for the complete range, including fittings.

Add C to the start of the Product Code.

Supplied complete with fixings.

Made to Order



Product Code **CHRL**

# CABLE TRAY

## Coupler

Product Code **HRC**

Outside Couplers are supplied in pairs and should be ordered separately for each length of tray as required.

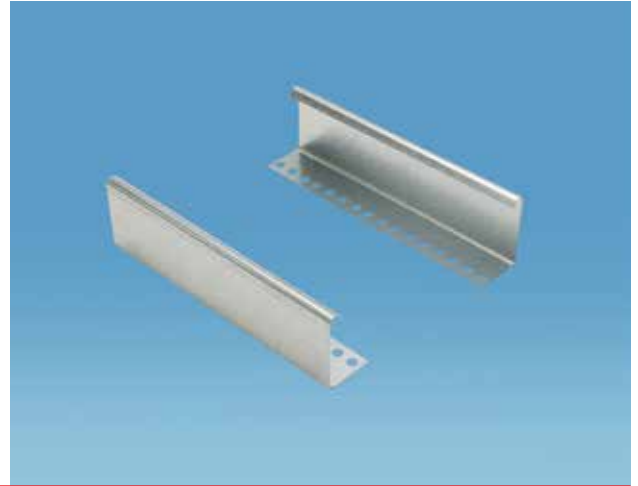

## Cranked Coupler

Product Code **HRCC**

Outside Cranked Couplers are supplied in pairs with the correct number being supplied with each tray fitting.

(Also available as separate items.)



## 90° Flat Bend

Product Code **HRB**

Width (mm)	Product Code 90°
75	HRB/75/90
100	HRB/100/90
150	HRB/150/90
225	HRB/225/90
300	HRB/300/90
450	HRB/450/90
600	HRB/600/90
750	HRB/750/90
900	HRB/900/90

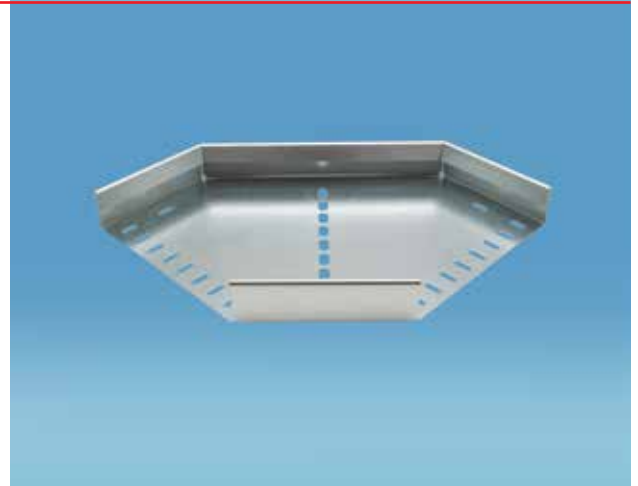

Flat Bend supplied with 2 x HRCC

## Flat Bend

Product Code **HRB**

Width (mm)	Product Code		
	30°	45°	60°
75	HRB/75/30	HRB/75/45	HRB/75/60
100	HRB/100/30	HRB/100/45	HRB/100/60
150	HRB/150/30	HRB/150/45	HRB/150/60
225	HRB/225/30	HRB/225/45	HRB/225/60
300	HRB/300/30	HRB/300/45	HRB/300/60
450	HRB/450/30	HRB/450/45	HRB/450/60
600	HRB/600/30	HRB/600/45	HRB/600/60
750	HRB/750/30	HRB/750/45	HRB/750/60
900	HRB/900/30	HRB/900/45	HRB/900/60



Flat Bend supplied with 2 x HRCC

30° & 60° Flat Bends are Made to Order

# CABLE TRAY

## Equal Tee

Product Code **HRT**

Width (mm)	Product Code
75	HRT/75
100	HRT/100
150	HRT/150
225	HRT/225
300	HRT/300
450	HRT/450
600	HRT/600
750	HRT/750
900	HRT/900

Equal Tee  
supplied with  
4 x HRCC

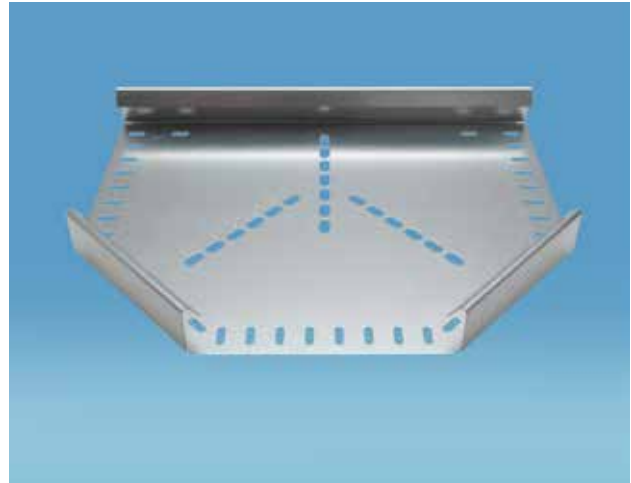

## Unequal Tee

Product Code **HRUT**

PLEASE STATE A AND B TRAY  
WIDTHS WHEN ORDERING

Made to Order

Unequal Tee  
supplied with  
4 x HRCC

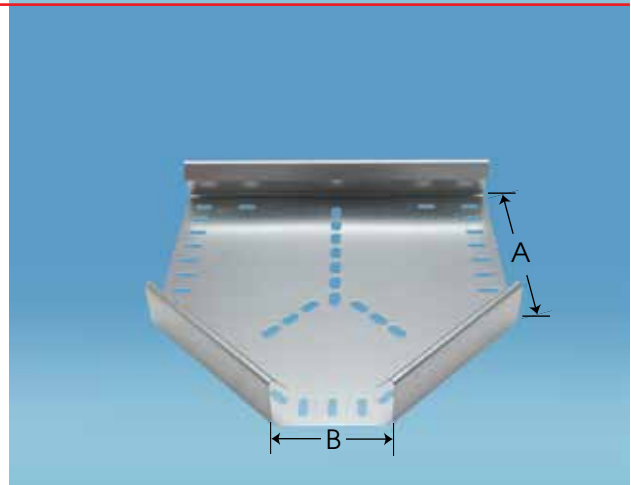

## Inside Riser

Product Code **HRIR**

Width (mm)	Product Code	
	90°	45°
75	HRIR/75/90	HRIR/75/45
100	HRIR/100/90	HRIR/100/45
150	HRIR/150/90	HRIR/150/45
225	HRIR/225/90	HRIR/225/45
300	HRIR/300/90	HRIR/300/45
450	HRIR/450/90	HRIR/450/45
600	HRIR/600/90	HRIR/600/45
750	HRIR/750/90	HRIR/750/45
900	HRIR/900/90	HRIR/900/45

Inside Riser  
supplied with  
2 x HRC

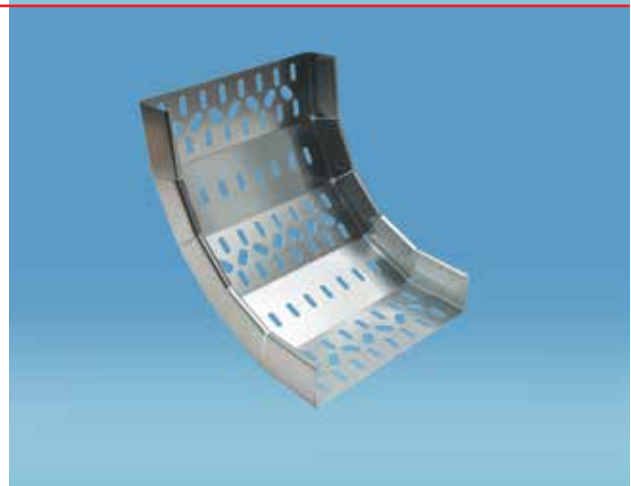

## Outside Riser

Product Code **HROR**

Width (mm)	Product Code	
	90°	45°
75	HROR/75/90	HROR/75/45
100	HROR/100/90	HROR/100/45
150	HROR/150/90	HROR/150/45
225	HROR/225/90	HROR/225/45
300	HROR/300/90	HROR/300/45
450	HROR/450/90	HROR/450/45
600	HROR/600/90	HROR/600/45
750	HROR/750/90	HROR/750/45
900	HROR/900/90	HROR/900/45

Outside Riser  
supplied with  
2 x HRC



# CABLE TRAY

## 4-Way Crosspiece

Product Code **HRX**

Width (mm)	Product Code
75	HRX/75
100	HRX/100
150	HRX/150
225	HRX/225
300	HRX/300
450	HRX/450
600	HRX/600
750	HRX/750
900	HRX/900

4-Way Crosspiece supplied with 8 x HRCC

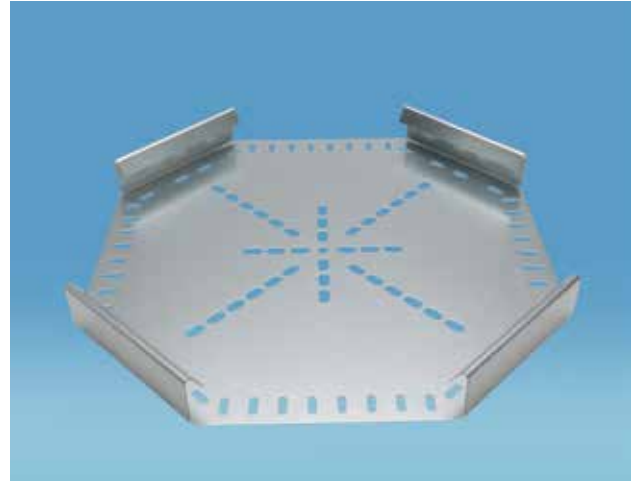

## Reducer

Product Code **HRR**

	Width 'A'								
	75	100	150	225	300	450	600	750	900
75	-	HRR/100/75	HRR/150/75	HRR/225/75	HRR/300/75	HRR/450/75	HRR/600/75	HRR/750/75	HRR/900/75
100	-	-	HRR/150/100	HRR/225/100	HRR/300/100	HRR/450/100	HRR/600/100	HRR/750/100	HRR/900/100
150	-	-	-	HRR/225/150	HRR/300/150	HRR/450/150	HRR/600/150	HRR/750/150	HRR/900/150
225	-	-	-	-	HRR/300/225	HRR/450/225	HRR/600/225	HRR/750/225	HRR/900/225
300	-	-	-	-	-	HRR/450/300	HRR/600/300	HRR/750/300	HRR/900/300
450	-	-	-	-	-	-	HRR/600/450	HRR/750/450	HRR/900/450
600	-	-	-	-	-	-	-	HRR/750/600	HRR/900/600
750	-	-	-	-	-	-	-	-	HRR/900/750

Reducer supplied with 2 x HRCC

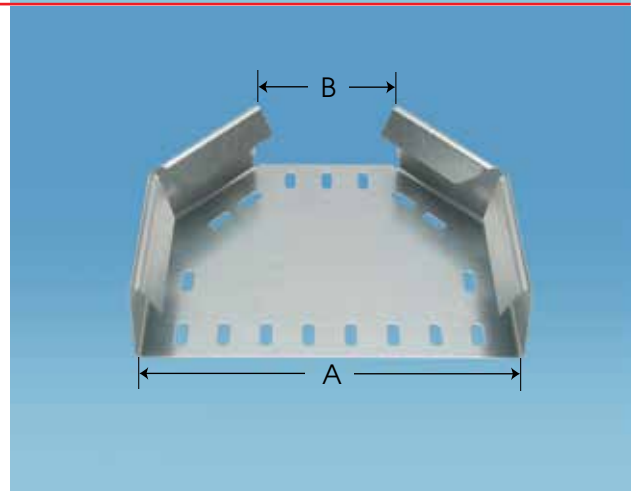

## Offset Reducer - Left Hand

Product Code **HRLR**

	Width 'A'								
	75	100	150	225	300	450	600	750	900
75	-	HRLR/100/75	HRLR/150/75	HRLR/225/75	HRLR/300/75	HRLR/450/75	HRLR/600/75	HRLR/750/75	HRLR/900/75
100	-	-	HRLR/150/100	HRLR/225/100	HRLR/300/100	HRLR/450/100	HRLR/600/100	HRLR/750/100	HRLR/900/100
150	-	-	-	HRLR/225/150	HRLR/300/150	HRLR/450/150	HRLR/600/150	HRLR/750/150	HRLR/900/150
225	-	-	-	-	HRLR/300/225	HRLR/450/225	HRLR/600/225	HRLR/750/225	HRLR/900/225
300	-	-	-	-	-	HRLR/450/300	HRLR/600/300	HRLR/750/300	HRLR/900/300
450	-	-	-	-	-	-	HRLR/600/450	HRLR/750/450	HRLR/900/450
600	-	-	-	-	-	-	-	HRLR/750/600	HRLR/900/600
750	-	-	-	-	-	-	-	-	HRLR/900/750

Made to Order

Reducer supplied with 2 x HRCC

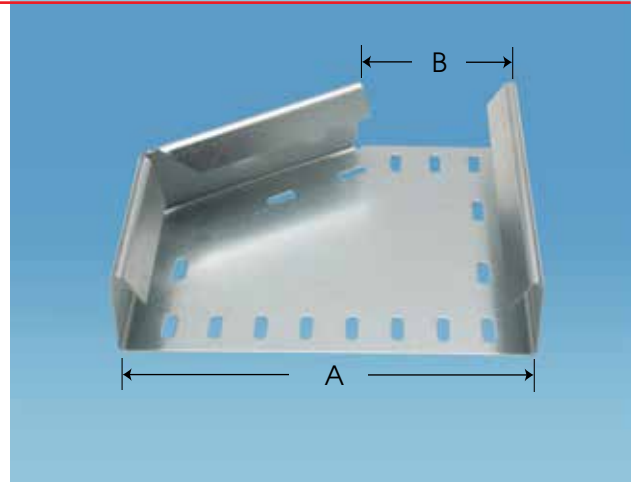

## Offset Reducer - Right Hand

Product Code **HRRR**

	Width 'A'								
	75	100	150	225	300	450	600	750	900
75	-	HRRR/100/75	HRRR/150/75	HRRR/225/75	HRRR/300/75	HRRR/450/75	HRRR/600/75	HRRR/750/75	HRRR/900/75
100	-	-	HRRR/150/100	HRRR/225/100	HRRR/300/100	HRRR/450/100	HRRR/600/100	HRRR/750/100	HRRR/900/100
150	-	-	-	HRRR/225/150	HRRR/300/150	HRRR/450/150	HRRR/600/150	HRRR/750/150	HRRR/900/150
225	-	-	-	-	HRRR/300/225	HRRR/450/225	HRRR/600/225	HRRR/750/225	HRRR/900/225
300	-	-	-	-	-	HRRR/450/300	HRRR/600/300	HRRR/750/300	HRRR/900/300
450	-	-	-	-	-	-	HRRR/600/450	HRRR/750/450	HRRR/900/450
600	-	-	-	-	-	-	-	HRRR/750/600	HRRR/900/600
750	-	-	-	-	-	-	-	-	HRRR/900/750

Made to Order

Reducer supplied with 2 x HRCC

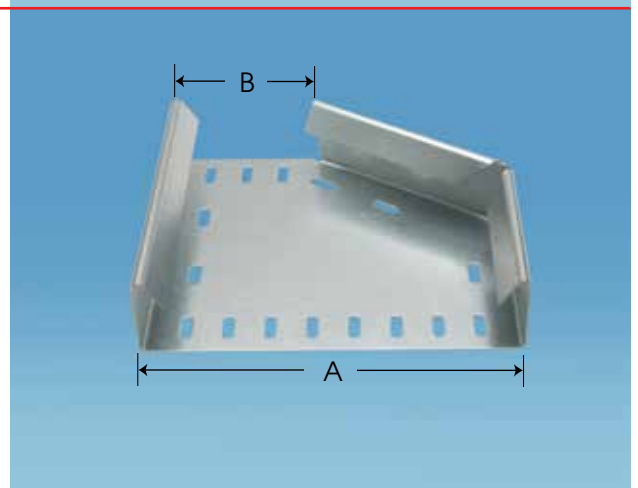

# CABLE TRAY ACCESSORIES

## Overhead Hanger

Product Code **OHH**

Width (mm)	Product Code
50	OHH/50
75	OHH/75
100	OHH/100
150	OHH/150
225	OHH/225
300	OHH/300



## Stand-off Bracket

Product Code **CA107**

Width (mm)	Product Code	Z mm
50	CA107/50	25
75	CA107/75	25
100	CA107/100	50
150	CA107/150	50
225	CA107/225	75
300	CA107/300	75
450	CA107/450	75
600	CA107/600	75
750	CA107/750	75
900	CA107/900	75

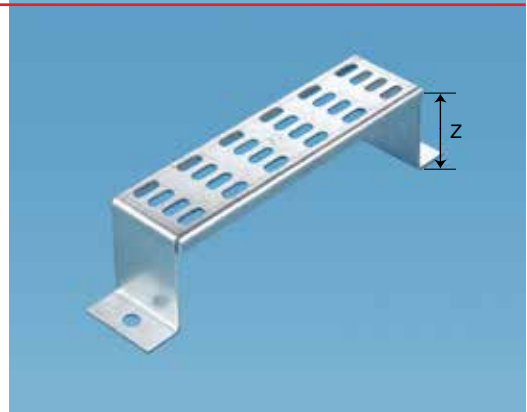

## Cantilever Arm

Product Code **CA106**

Width (mm)	Product Code
100	CA106/100
150	CA106/150
225	CA106/225
300	CA106/300
450	CA106/450
600	CA106/600
750	CA106/750
900	CA106/900

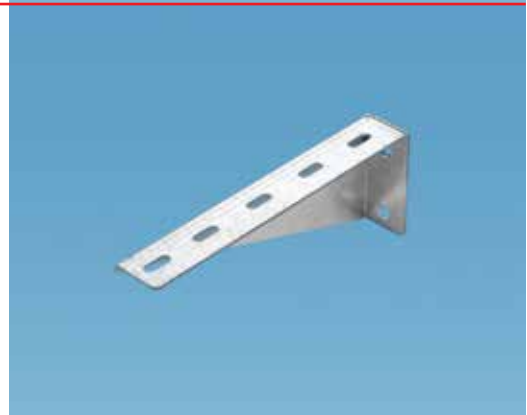

## Fishplate

Product Code **FPC**

Width (mm)	Product Code	A mm
150	FPC/150	75
225	FPC/225	150
300	FPC/300	225
450	FPC/450	375
600	FPC/600	525
750	FPC/750	675
900	FPC/900	825

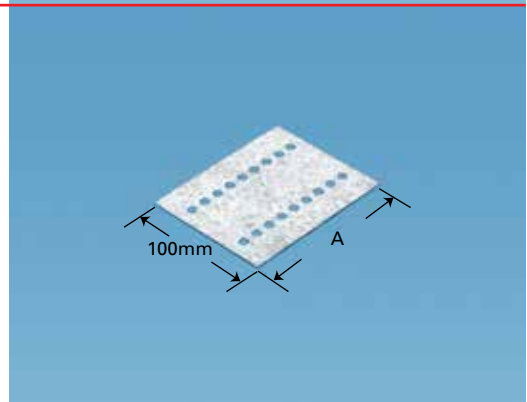

## Cover Bracket

Product Code **HR/BRK**



## Earth Continuity Connector

Product Code **TECC100**



## Standard Vertical Flange Cable Tray



---

### Flange Profile



---

### Unique Slot Pattern

Cable clamps can be attached to the larger 20 x 11 slots using up to M10 fixings without drilling.

Longitudinal running 20 x 7 slots permit use of cable ties up to 20mm wide, correctly positioned across the width of the tray instead of staggered as with conventional patterns.

The tray length may be cut at any position along the 3 metre axis and can still be connected to any fitting or adjoining length without drilling.

# CABLE TRAY

## Tray Lengths

Product Code	Tray Width (mm)	Flange Height (mm)
SVL/50	50	15

		Code Suffix
<b>BRITISH STANDARD</b>	Complies with BS EN 61537	
<b>FULL TECHNICAL SUBMITTAL AVAILABLE ON REQUEST</b>		
<b>STANDARD LENGTH</b>	3.0 metres	
<b>STANDARD FINISH</b>	Hot-Dip Pre-Galvanised to BS EN 10346	<b>/G</b>
<b>SPECIAL FINISH</b>	Epoxy Powder Coated Black/White	<b>/EP</b>

## Cable Tray Covers

**STANDARD LENGTH** 1.5 metres

Covers are available for the complete range, including fittings.

Add C to the start of the Product Code.

Supplied complete with fixings.

Made to Order

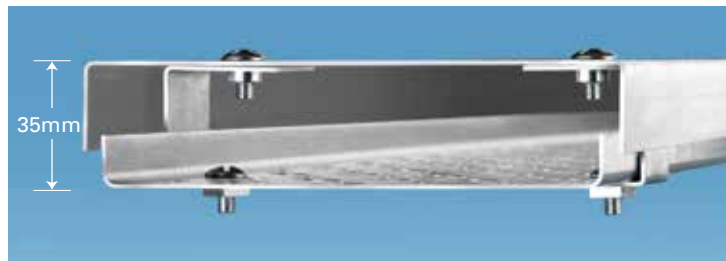

**Cover CSVL**

# CABLE TRAY

## Coupler

Product Code **SVC**

Outside Couplers are supplied in pairs and should be ordered per length of tray as required.

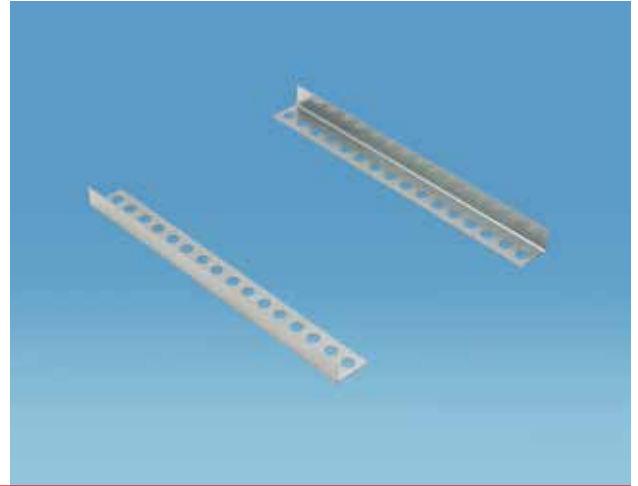

## Cranked Coupler

Product Code **SVCC**

Outside Cranked Couplers are supplied in pairs with the correct number being supplied with each tray fitting.

(Also available as separate items.)



## Flat Bend

Product Code **SVB**

Width (mm)	Product Code	
	90°	45°
50	SVB/50/90	SVB/50/45

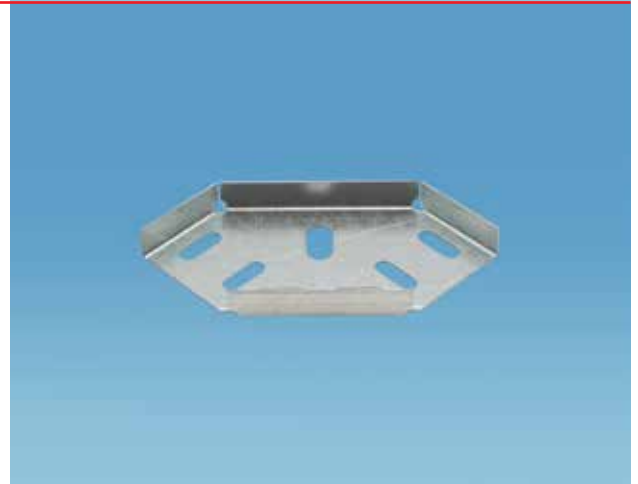

Flat Bend supplied with 2 x SVCC

## Equal Tee

Product Code **SVT**

Width (mm)	Product Code
50	SVT/50



Equal Tee supplied with 4 x SVCC



# CABLE TRAY

## 4-Way Crosspiece

Product Code **SVX**

Width (mm)	Product Code
50	SVX/50

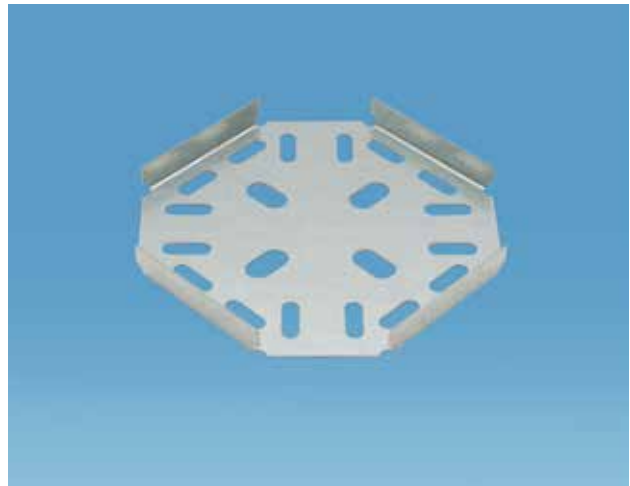

4-Way Crosspiece  
supplied with  
8 x SVCC

## Inside Riser

Product Code **SVIR**

Width (mm)	Product Code	
	90°	45°
50	SVIR/50/90	SVIR/50/45

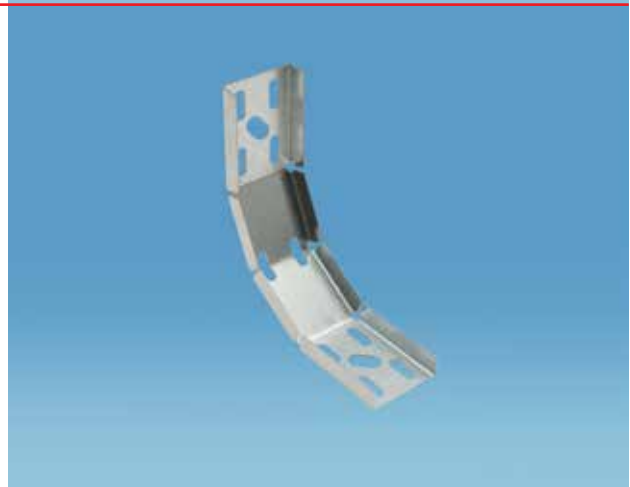

Inside Riser  
supplied with  
2 x SVC

## Outside Riser

Product Code **SVOR**

Width (mm)	Product Code	
	90°	45°
50	SVOR/50/90	SVOR/50/45



Outside Riser  
supplied with  
2 x SVC

# CABLE TRAY ACCESSORIES

## Overhead Hanger

Product Code **OHH**

Width (mm)	Product Code
50	OHH/50
75	OHH/75
100	OHH/100
150	OHH/150
225	OHH/225
300	OHH/300



## Stand-off Bracket

Product Code **CA107**

Width (mm)	Product Code	Z mm
50	CA107/50	25
75	CA107/75	25
100	CA107/100	50
150	CA107/150	50
225	CA107/225	75
300	CA107/300	75
450	CA107/450	75
600	CA107/600	75
750	CA107/750	75
900	CA107/900	75

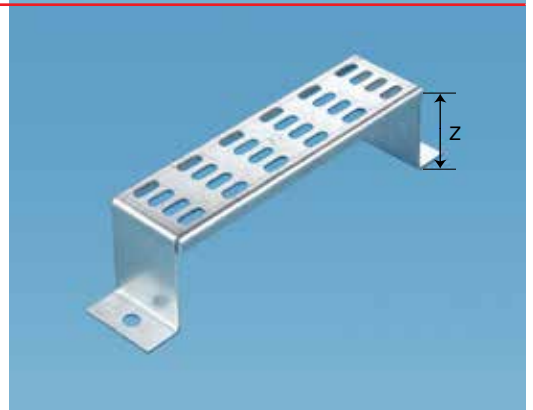

## Cantilever Arm

Product Code **CA106**

Width (mm)	Product Code
100	CA106/100
150	CA106/150
225	CA106/225
300	CA106/300
450	CA106/450
600	CA106/600
750	CA106/750
900	CA106/900



## Fishplate

Product Code **FPC**

Width (mm)	Product Code	A mm
150	FPC/150	75
225	FPC/225	150
300	FPC/300	225
450	FPC/450	375
600	FPC/600	525
750	FPC/750	675
900	FPC/900	825

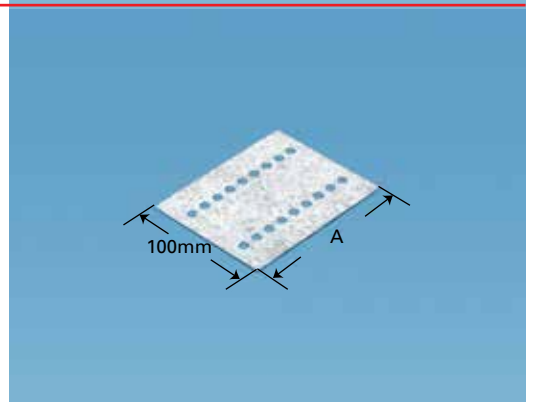

## Cover Bracket

Product Code **SV/BRK**



## Earth Continuity Connector

Product Code **TECC100**





# BASKET TRAY

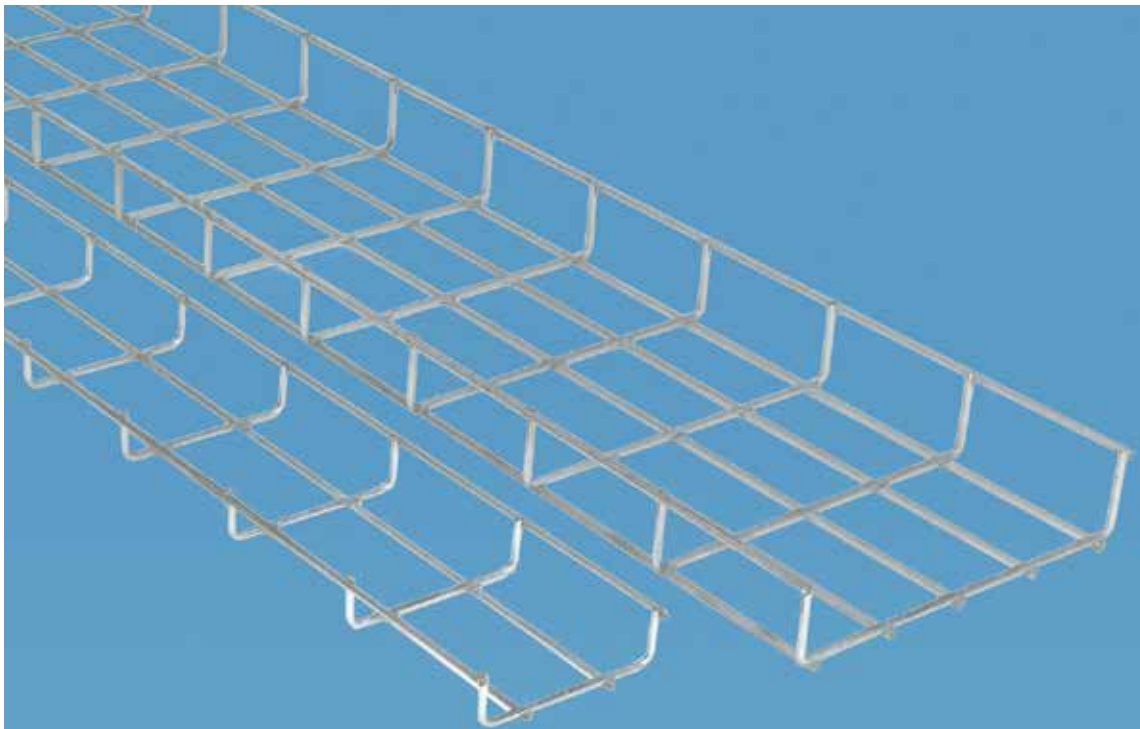

# BASKET TRAY

## Medium Duty Basket Tray

<b>British Standard</b>	BS EN 61537
<b>Height</b>	30mm
<b>Standard Length</b>	3.0 metres
<b>Finish</b>	Hot-Dip Pre-Galvanised to BS EN 10244
<b>Special Finish</b> (WB30 WB55 WB105)	Epoxy Powder Coated Black/White

FULL TECHNICAL SUBMITTAL AVAILABLE ON REQUEST

Product Code	Basket Tray Width (mm)
WB30/100/G	100
WB30/150/G	150
WB30/200/G	200
WB30/300/G	300

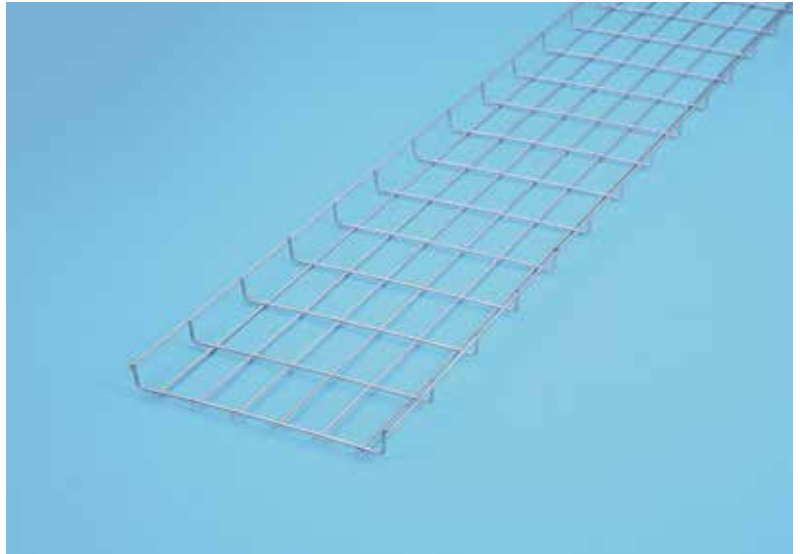

## Heavy Duty Basket Tray

<b>British Standard</b>	BS EN 61537
<b>Height</b>	55mm
<b>Standard Length</b>	3.0 metres
<b>Finish</b>	Hot-Dip Pre-Galvanised to BS EN 10244

FULL TECHNICAL SUBMITTAL AVAILABLE ON REQUEST

Product Code	Basket Tray Width (mm)
WB55/50/G	50
WB55/100/G	100
WB55/150/G	150
WB55/200/G	200
WB55/300/G	300
WB55/400/G	400
WB55/450/G	450
WB55/500/G	500
WB55/600/G	600

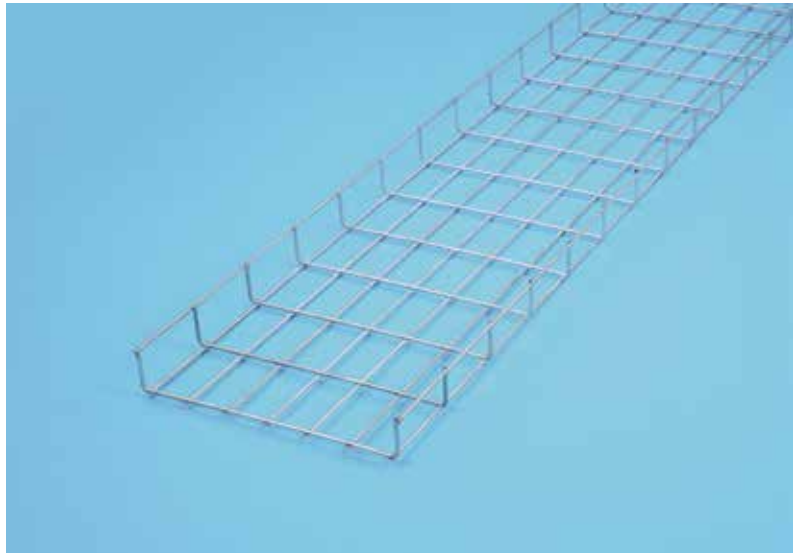

## Deep Heavy Duty Basket Tray

<b>British Standard</b>	BS EN 61537
<b>Height</b>	105mm
<b>Standard Length</b>	3.0 metres
<b>Finish</b>	Hot-Dip Pre-Galvanised to BS EN 10244

FULL TECHNICAL SUBMITTAL AVAILABLE ON REQUEST

Product Code	Basket Tray Width (mm)
WB105/100/G	100
WB105/150/G	150
WB105/200/G	200
WB105/300/G	300
WB105/400/G	400
WB105/450/G	450
WB105/500/G	500
WB105/600/G	600



# BASKET TRAY

## Joint Clamp



Product Code: **WB/JC**

Supplied separately as single item.

Basket Tray Width (mm)	Recommended Number of Joint Clamps per Coupling
50	2
100	2
150	3
200	3
300	4
400	4
500	4
600	4

## Quick Coupler

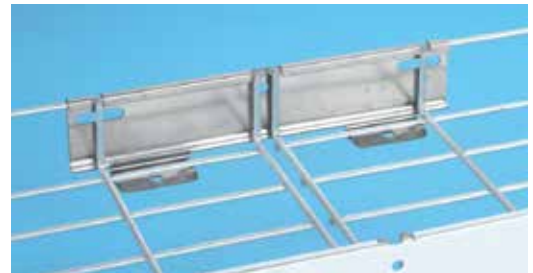

Product Code:

**WB30/QC** For Medium Duty Tray

**WB55/QC** For Heavy Duty Tray

**WB55/QC** For Deep Heavy Duty Tray

Use 2 per coupling for all widths of tray -supplied as single item.

## Joint Strip



Product Code: **WB/JS**

Fix using WB/FC Fixing Clamp - supplied separately.

## Fixing Clamp



Product Code: **WB/FC**

Use to fix brackets.

Supplied as single item.

## Channel Hold Down Plate

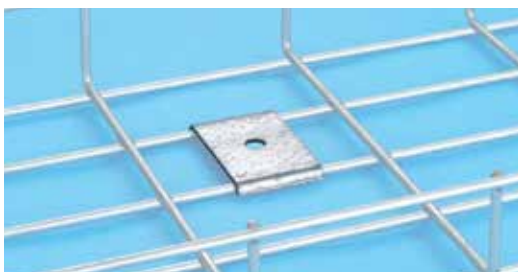

Product Code: **WB/CHP**

Use to fix tray to Channel Supports. (41 x 21mm and 41 x 41 mm)

Suitable for up to M8 fixing - supplied separately.

## Suspension Bracket



Product Code:

**WB30/SB** For Medium Duty Tray

**WB55/SB** For Heavy Duty Tray

**WB55/SB** For Deep Heavy Duty Tray

Suitable for up to M10 Threaded Rod - supplied separately.

Supplied as single item.

# BASKET TRAY

## Central Hanger Clamp

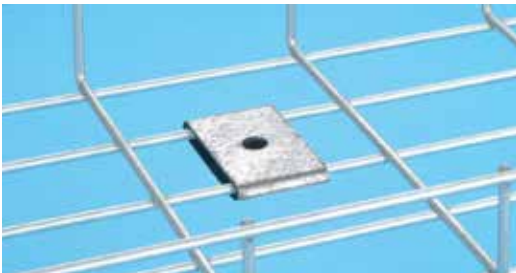

Product Code: **WB/CHC**

Suitable for up to M10 Threaded Rod -supplied separately.

## Conduit Plate

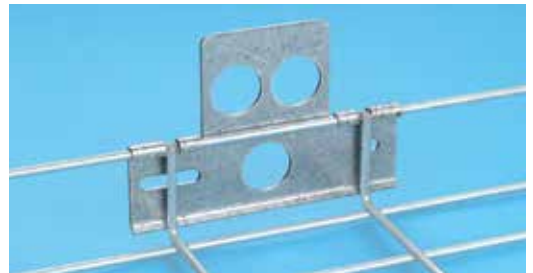

Product Code: **WB/CP**

Fix using 2 x WB/FC Fixing Clamp - supplied separately.

## Drop Out Plate

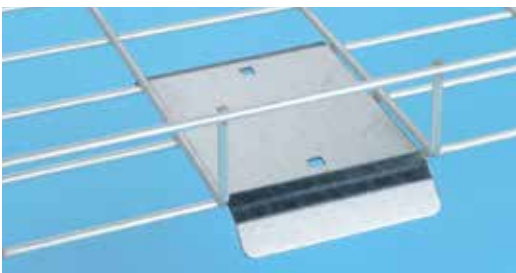

Product Code: **WB/DOP**

Provides support at cable entry and exit. Fix using 2 x WB/FC Fixing Clamp -supplied separately.

## Stand Off Bracket



Product Code: **WB/SOB/** (Width)

Available for all Basket Tray Widths

50mm high.

## Divider

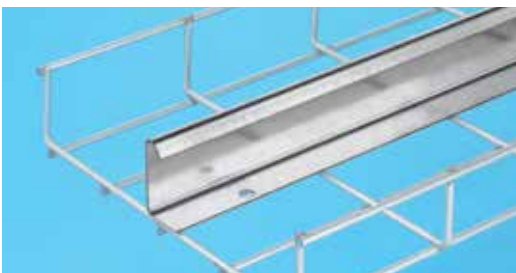

**Length:** 3.0 metres

Fix using 4 x WB/FC Fixing Clamp - supplied separately.

Product Code	Type
WB30/DV	MEDIUM DUTY
WB55/DV	HEAVY DUTY
WB105/DV	DEEP HEAVY DUTY

## Cover



**Length:** 1.5 metres

Fix using 4 x WB/FC Fixing Clamp -supplied separately.

Product Code	Basket Tray Width (mm)
WB55C/50	50
WB30C/100	100
WB55C/100	100
WB30C/150	150
WB55C/150	150
WB30C/200	200
WB55C/200	200
WB30C/300	300
WB55C/300	300
WB55C/400	400
WB55C/450	450
WB55C/500	500
WB55C/600	600

## Earth Continuity Connector

Product Code **TECC100**





# CABLE LADDER

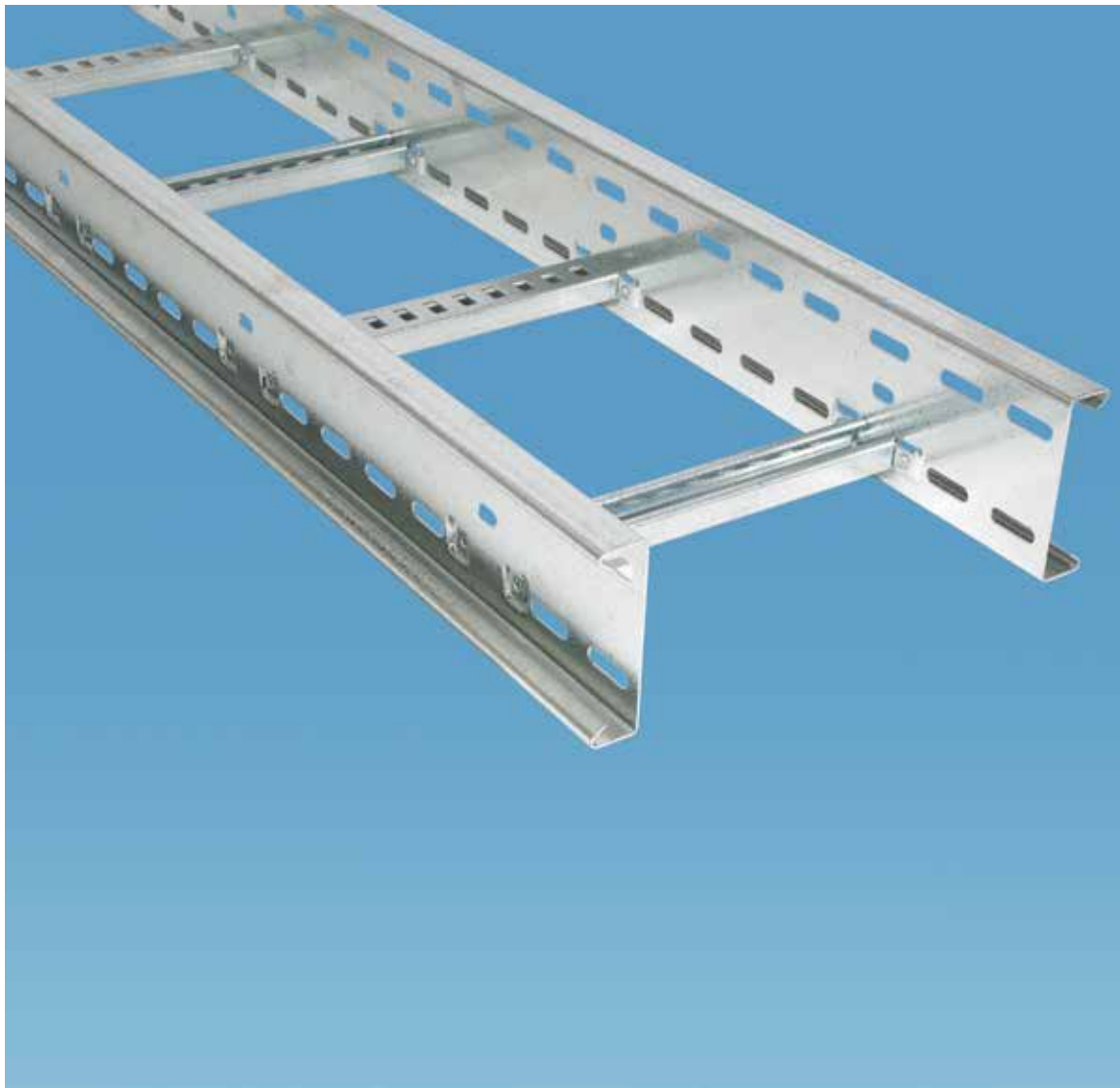

# CABLE LADDER

## L4 Cable Ladder Medium Duty - 100mm Sidewall



Product Code	Ladder Width (mm)	Sidewall Height (mm)
L4L/150	150	100
L4L/300	300	100
L4L/450	450	100
L4L/600	600	100
L4L/750	750	100
L4L/900	900	100

## L5 Cable Ladder Heavy Duty - 125mm Sidewall

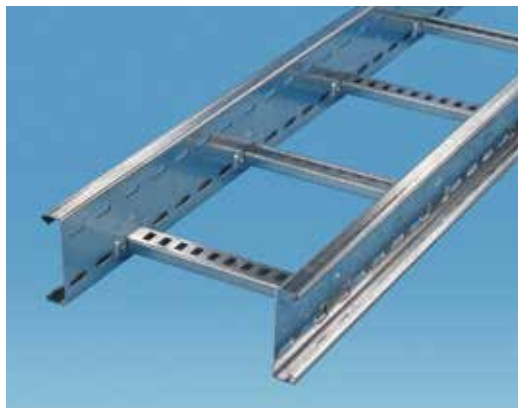

Product Code	Ladder Width (mm)	Sidewall Height (mm)
L5L/150	150	125
L5L/300	300	125
L5L/450	450	125
L5L/600	600	125
L5L/750	750	125
L5L/900	900	125

## L6 Cable Ladder Extra Heavy Duty - 150mm Sidewall

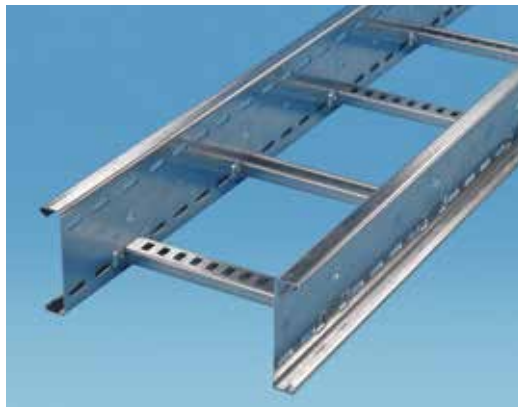

Product Code	Ladder Width (mm)	Sidewall Height (mm)
L6L/150	150	150
L6L/300	300	150
L6L/450	450	150
L6L/600	600	150
L6L/750	750	150
L6L/900	900	150

		Code Suffix
<b>BRITISH STANDARD</b>	Complies with BS EN 61537	
<b>FULL TECHNICAL SUBMITTAL AVAILABLE ON REQUEST</b>		
<b>STANDARD LENGTH</b>	3.0 metres	
<b>STANDARD FINISH</b>	Hot-Dip Pre-Galvanised to BS EN 10346	<b>/G</b>
<b>SPECIAL FINISH</b>	Epoxy Powder Coated Black/White	<b>/EP</b>
All couplers must be ordered separately.		



# CABLE LADDER

## Flat Bend

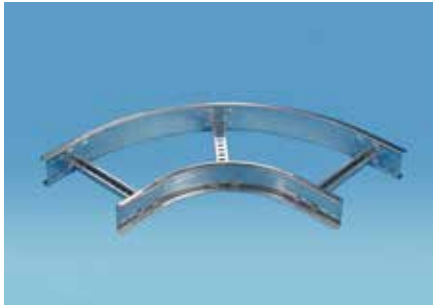

### Other Angles available:

30, 45, and 60 degrees

### Other Radii available:

450, 600, 750, and 900mm

Product Code	Ladder Width (mm)	Sidewall Height (mm)	Angle (degrees)	Radius (mm)
L4B/150/90/R300	150	100	90	300
L4B/300/90/R300	300	100	90	300
L4B/450/90/R300	450	100	90	300
L4B/600/90/R300	600	100	90	300
L4B/750/90/R300	750	100	90	300
L4B/900/90/R300	900	100	90	300
L5B/150/90/R300	150	125	90	300
L5B/300/90/R300	300	125	90	300
L5B/450/90/R300	450	125	90	300
L5B/600/90/R300	600	125	90	300
L5B/750/90/R300	750	125	90	300
L5B/900/90/R300	900	125	90	300
L6B/150/90/R300	150	150	90	300
L6B/300/90/R300	300	150	90	300
L6B/450/90/R300	450	150	90	300
L6B/600/90/R300	600	150	90	300
L6B/750/90/R300	750	150	90	300
L6B/900/90/R300	900	150	90	300

## Equal Tee

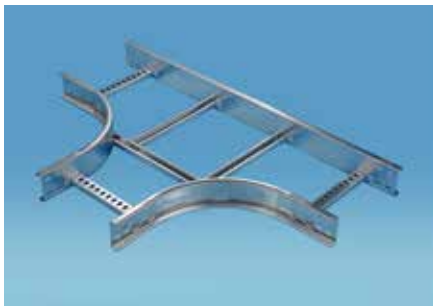

### Other Radii available:

450, 600, 750, and 900mm

Product Code	Ladder Width (mm)	Sidewall Height (mm)	Radius (mm)
L4T/150/R300	150	100	300
L4T/300/R300	300	100	300
L4T/450/R300	450	100	300
L4T/600/R300	600	100	300
L4T/750/R300	750	100	300
L4T/900/R300	900	100	300
L5T/150/R300	150	125	300
L5T/300/R300	300	125	300
L5T/450/R300	450	125	300
L5T/600/R300	600	125	300
L5T/750/R300	750	125	300
L5T/900/R300	900	125	300
L6T/150/R300	150	150	300
L6T/300/R300	300	150	300
L6T/450/R300	450	150	300
L6T/600/R300	600	150	300
L6T/750/R300	750	150	300
L6T/900/R300	900	150	300

# CABLE LADDER

## Unequal Tee

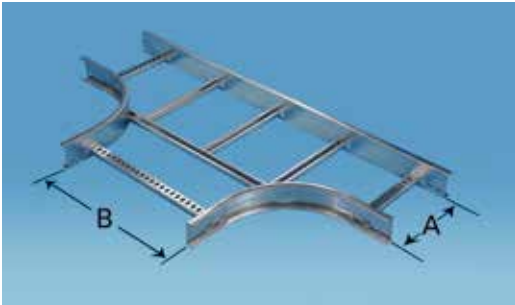

Product Code	Ladder Width		Sidewall Height (mm)	Radius (mm)
	A (mm)	B (mm)		
L4UT/A/B/R300	PLEASE STATE WHEN ORDERING		100	300
L5UT/A/B/R300			125	300
L6UT/A/B/R300			150	300

**Other Radii available:**

450, 600, 750, and 900mm

## Straight Reducer

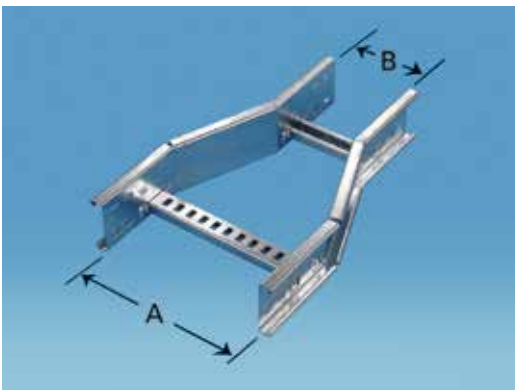

Product Code	Ladder Width		Sidewall Height (mm)
	A (mm)	B (mm)	
L4SR/A/B	PLEASE STATE WHEN ORDERING		100
L5SR/A/B			125
L6SR/A/B			150

## Offset Reducer - Left Hand

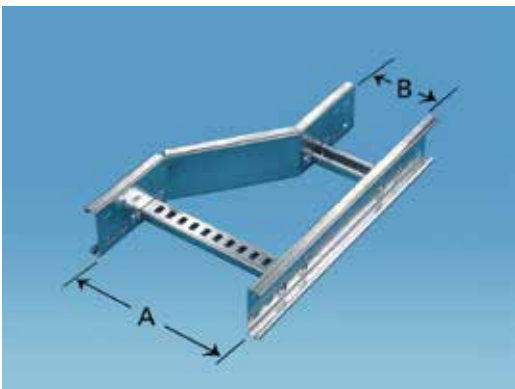

Product Code	Ladder Width		Sidewall Height (mm)
	A (mm)	B (mm)	
L4LR/A/B	PLEASE STATE WHEN ORDERING		100
L5LR/A/B			125
L6LR/A/B			150

## Offset Reducer - Right Hand

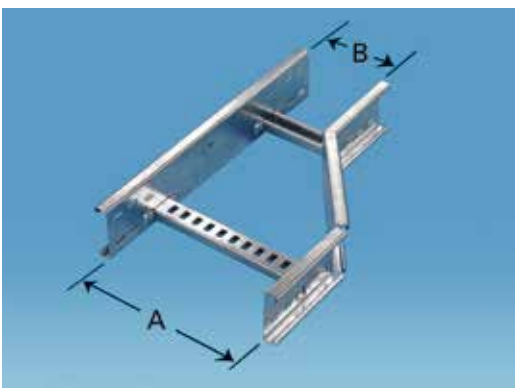

Product Code	Ladder Width		Sidewall Height (mm)
	A (mm)	B (mm)	
L4RR/A/B	PLEASE STATE WHEN ORDERING		100
L5RR/A/B			125
L6RR/A/B			150

# CABLE LADDER

## Inside Riser



**Other Angles available:**

30, 45, and 60 degrees

**Other Radii available:**

450, 600, 750, and 900mm

Product Code	Ladder Width (mm)	Sidewall Height (mm)	Angle (degrees)	Radius (mm)
L4IR/150/90/R300	150	100	90	300
L4IR/300/90/R300	300	100	90	300
L4IR/450/90/R300	450	100	90	300
L4IR/600/90/R300	600	100	90	300
L4IR/750/90/R300	750	100	90	300
L4IR/900/90/R300	900	100	90	300
L5IR/150/90/R300	150	125	90	300
L5IR/300/90/R300	300	125	90	300
L5IR/450/90/R300	450	125	90	300
L5IR/600/90/R300	600	125	90	300
L5IR/750/90/R300	750	125	90	300
L5IR/900/90/R300	900	125	90	300
L6IR/150/90/R300	150	150	90	300
L6IR/300/90/R300	300	150	90	300
L6IR/450/90/R300	450	150	90	300
L6IR/600/90/R300	600	150	90	300
L6IR/750/90/R300	750	150	90	300
L6IR/900/90/R300	900	150	90	300

## Outside Riser



**Other Angles available:**

30, 45, and 60 degrees

**Other Radii available:**

450, 600, 750, and 900mm

Product Code	Ladder Width (mm)	Sidewall Height (mm)	Angle (degrees)	Radius (mm)
L4OR/150/90/R300	150	100	90	300
L4OR/300/90/R300	300	100	90	300
L4OR/450/90/R300	450	100	90	300
L4OR/600/90/R300	600	100	90	300
L4OR/750/90/R300	750	100	90	300
L4OR/900/90/R300	900	100	90	300
L5OR/150/90/R300	150	125	90	300
L5OR/300/90/R300	300	125	90	300
L5OR/450/90/R300	450	125	90	300
L5OR/600/90/R300	600	125	90	300
L5OR/750/90/R300	750	125	90	300
L5OR/900/90/R300	900	125	90	300
L6OR/150/90/R300	150	150	90	300
L6OR/300/90/R300	300	150	90	300
L6OR/450/90/R300	450	150	90	300
L6OR/600/90/R300	600	150	90	300
L6OR/750/90/R300	750	150	90	300
L6OR/900/90/R300	900	150	90	300

# CABLE LADDER

## 4-Way Crosspiece

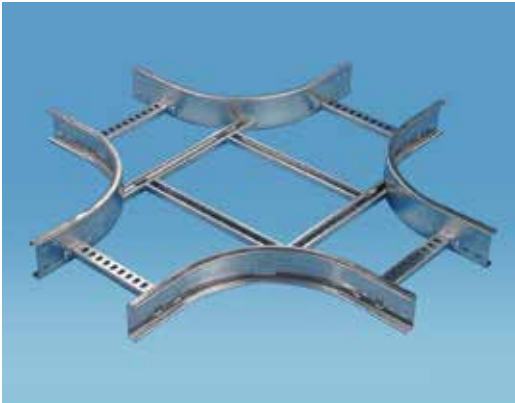

### Other Radii available:

450, 600, 750, and 900mm

Product Code	Ladder Width (mm)	Sidewall Width (mm)	Radius (mm)
L4X/150/R300	150	100	300
L4X/300/R300	300	100	300
L4X/450/R300	450	100	300
L4X/600/R300	600	100	300
L4X/750/R300	750	100	300
L4X/900/R300	900	100	300
L5X/150/R300	150	125	300
L5X/300/R300	300	125	300
L5X/450/R300	450	125	300
L5X/600/R300	600	125	300
L5X/750/R300	750	125	300
L5X/900/R300	900	125	300
L6X/150/R300	150	150	300
L6X/300/R300	300	150	300
L6X/450/R300	450	150	300
L6X/600/R300	600	150	300
L6X/750/R300	750	150	300
L6X/900/R300	900	150	300



### Straight Divider Length: 3.0 metres

Product Code	Sidewall Width (mm)
L4DV	100
L5DV	125
L6DV	150

### Curved Divider Length: 1.5 metres

Product Code	Sidewall Width (mm)
L4CUR	100
L5CUR	125
L6CUR	150

## Cover

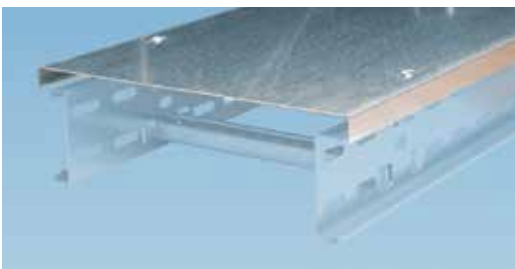

Covers are available for the complete range, including accessories.

Add C to the start of the Product Code.

Ordering Details - e.g. 4-Way Crosspiece Cover for 150mm wide Ladder with 300mm radius - Product Code CL4X/150/R300/G

Supplied complete with fixings. Length: 1.5 metres

# CABLE LADDER

## Coupler



Product Code	Sidewall Height (mm)
L4C	100
L5C	125
L6C	150

Supplied in pairs complete with nuts, bolts and washers.

## Vertical Hinged Connector



Product Code	Sidewall Height (mm)
L4V	100
L5V	125
L6V	150

Supplied in pairs complete with nuts, bolts and washers.

A pair consists of 4 components

## Horizontal Hinged Connector



Product Code	Sidewall Height (mm)
L4H	100
L5H	125
L6H	150

Supplied in pairs complete with nuts, bolts and washers.

## Earth Continuity Strap

Product Code: **LECS**



## Cover Bracket

Product Code: **LAD/BRK**



## Coupler Fixings

Product Code: **LADFX**



Each pack consists of 16 x M10 nuts, bolts and spring washers.

## CABLE LADDER



### Hold Down Clip

Product Code: **LHC**

Supplied as single item.

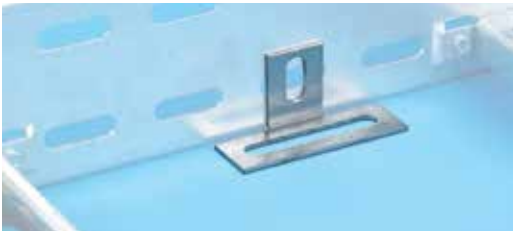

### Boltable Hold Down Bracket

Product Code: **LBHB**

Supplied as single item.

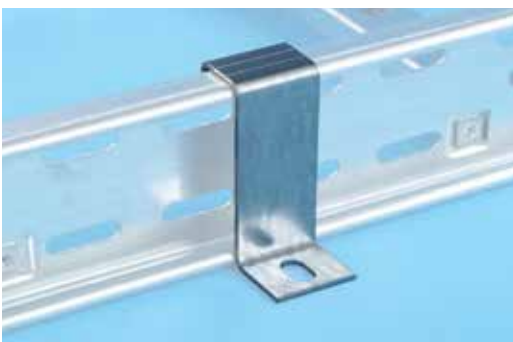

### Hold Down Bracket

Product Code	Sidewall Height (mm)
L4HB	100
L5HB	125
L6HB	150

Supplied as single item.

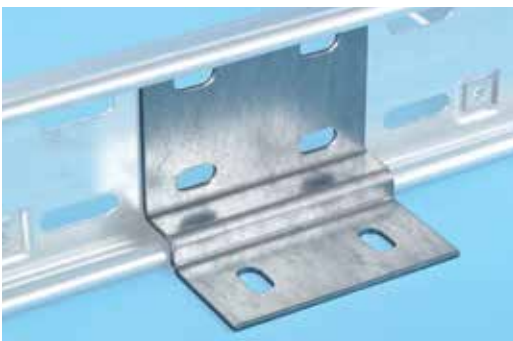

### Wall Bracket

Product Code	Sidewall Height (mm)
L4WB	100
L5WB	125
L6WB	150

Supplied as single item.

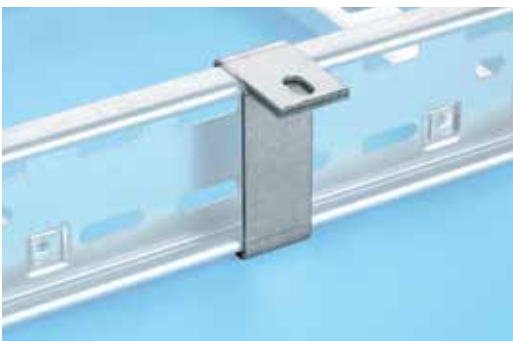

### Suspension Clip

Product Code	Sidewall Height (mm)
L4SC	100
L5SC	125
L6SC	150

Supplied as single item.



### Suspension Bracket

Product Code	Sidewall Height (mm)
L4SB	100
L5SB	125
L6SB	150

Supplied as single item.



# CHANNEL SUPPORT SYSTEMS



# CHANNEL SUPPORT SYSTEMS

## Standard Channels

		Code Suffix
<b>BRITISH STANDARD</b>	Complies with BS 6946	
<b>FULL TECHNICAL SUBMITTAL AVAILABLE ON REQUEST</b>		
<b>STANDARD LENGTH</b>	3.0 metres and 6.0 metres	
<b>STANDARD THICKNESS</b>	2.5mm	
<b>STANDARD FINISH</b>	Hot-Dip Pre-Galvanised to BS EN 10346	<b>/G</b>

**CH101**  
Weight 2.6 Kg/m

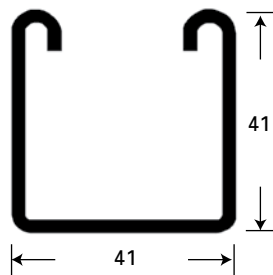

**CH103**  
Weight 5.2 Kg/m

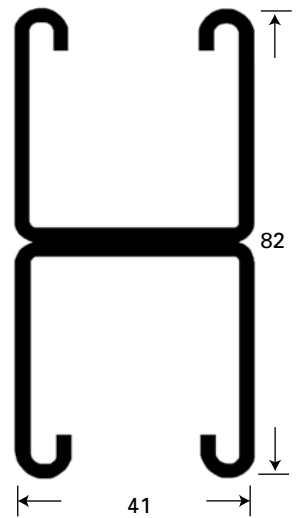

**CH104**  
Weight 1.8 Kg/m

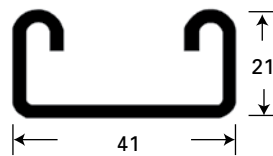

**CH105**  
Weight 3.6 Kg/m

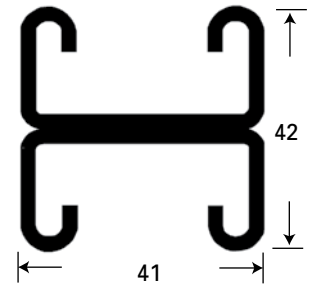

## Slotted Channel

Channels are available with pre-punched slots to facilitate easy fixing.

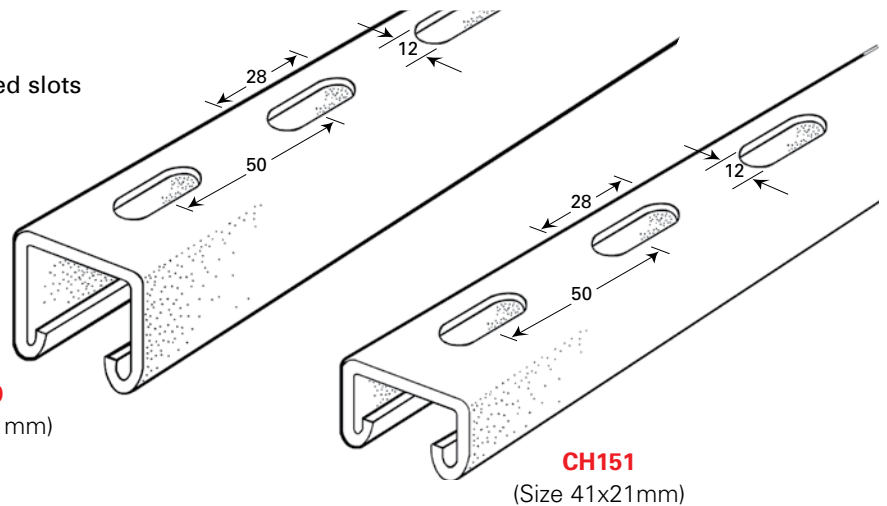

**CH150**  
(Size 41x41mm)

**CH151**  
(Size 41x21mm)



# CHANNEL SUPPORT SYSTEMS

## Supports

**Cantilever Arms** DIMENSION A  
 150mm  
 225mm  
 300mm  
 450mm  
 600mm  
 750mm

**CA101**

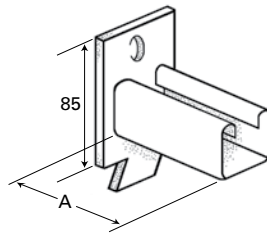

**CA104**

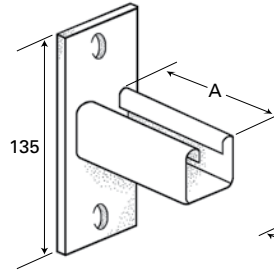

**CA105**

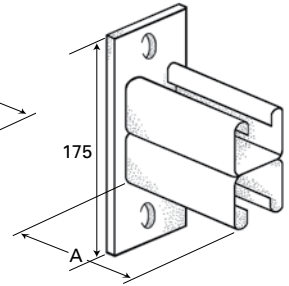

## Cantilever Tray Brackets

**CA106**

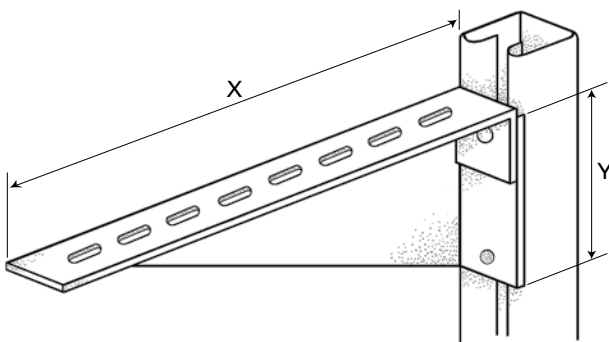

## Stand-off Tray Brackets

**CA107**

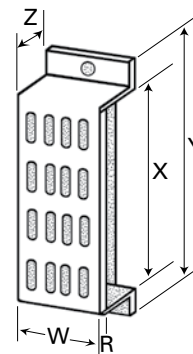

Product Code	x mm	y mm
CA106/100	100	70
CA106/150	150	70
CA106/225	225	90
CA106/300	300	90
CA106/450	450	130
CA106/600	600	130
CA106/750	750	130
CA106/900	900	130

Galvanised BS EN 10346

Product Code	x mm	y mm	z mm	w mm	Return R
CA107/50	55	105	25	55	-
CA107/75	80	130	25	55	-
CA107/100	105	155	50	55	-
CA107/150	155	205	50	55	10
CA107/225	230	280	75	55	10
CA107/300	305	355	75	55	10
CA107/450	455	505	75	55	10
CA107/600	605	655	75	55	10
CA107/750	755	805	75	55	10
CA107/900	905	955	75	55	10

Galvanised BS EN 10346

# CHANNEL SUPPORT SYSTEMS

## Fixings

ALL FIXINGS ARE BRIGHT ZINC PLATED  
TO BS7371

### Threaded Rod (Mild Steel)

**FX275/**  
M6x3m  
M8x3m  
M10x3m  
M12x3m



### Full Hexagon Nuts

**FX154/**  
M6  
M8  
M10  
M12

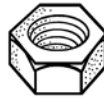

### Plain Flat Washers

**FX198/**  
INT EXT  
DIA DIA  
M6 12mm  
M8 17mm  
M10 21mm  
M12 24mm



### Penny / Mudguard Washers

**FX202/**  
INT EXT  
DIA DIA  
M6 30mm  
M8 30mm  
M10 30mm



### Spring Washers (Single Coil)

**FX206/**  
M6  
M8  
M10  
M12



### Shakeproof Washers

**FX213/**  
M6  
M8  
M10  
M12



### Hexagon Head Set Screws

**FX132/**  
M6x12 M8x16 M10x20 M12x22  
M6x16 M8x20 M10x25 M12x25  
M6x20 M8x25 M10x30 M12x30  
M6x25 M8x30 M10x35 M12x35  
M6x30 M6x35 M10x40 M12x40  
M6x35 M8x40 M10x50 M12x50  
M6x40 M8x50 M10x60 M12x60  
M6x50 M8x60 M10x80 M12x80  
M6x60



### Tray Bolts & Nuts

**FX281/**  
M6x12  
M6x16  
M6x20  
M6x25  
M6x30  
M6x35  
M6x40  
M6x50  
M6x60  
M6x70

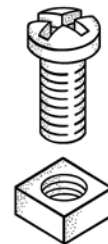

### Threaded Rod Cover Caps

**FX276/**  
M6  
M8  
M10  
M12



### Threaded Rod Connectors

**FX384/**  
M6  
M8  
M10  
M12



### Eye Bolts

**FX385/**  
M6x80  
M8x80  
M10x80  
M12x80



# CHANNEL SUPPORT SYSTEMS

## Channel Nuts

STANDARD FINISH - BRIGHT ZINC PLATED  
TO BS7371

### Long Spring

**CN701/**



Deep Channel

CN701/6 M6  
CN701/8 M8  
CN701/10 M10  
CN701/12 M12



### Short Spring

**CN702/**



Shallow Channel

CN702/6 M6  
CN702/8 M8  
CN702/10 M10  
CN702/12 M12

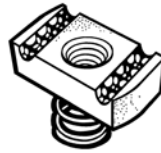

### No Spring

**CN703/**

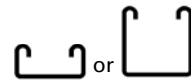

Shallow Channel or Deep Channel

CN703/6 M6  
CN703/8 M8  
CN703/10 M10  
CN703/12 M12



## Plastic End Caps

**CL505** - Black  
**CL515** - White

**CL506** - Black  
**CL516** - White



Deep Channel



Shallow Channel

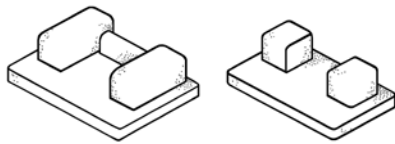

## Closure Strip

**CL504**

/W White PVC  
/G Galvanised to BS EN 10346

Supplied in 3m lengths

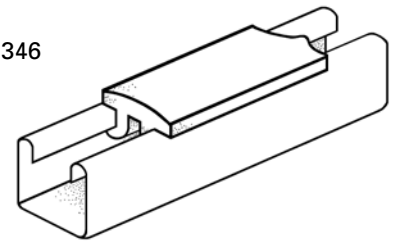

## Purlin 'D' Clip

**PD** Hole diameter  
11mm

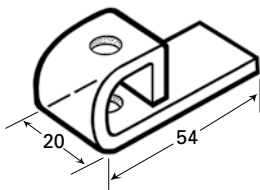

## Flange Clamp

**FC-1** M8  
**FC-2** M10  
**FC-3** M12

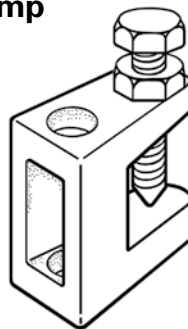

## Wedge Nuts

**FX400/**  
M6  
M8  
M10

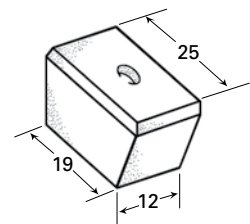

## Drop-in Anchors



Product Code	Thread Size (mm)	Anchor Dia (mm)	Thread Depth (mm)	Overall Length (mm)	Setting Tool Product Code
FX366	6	8	10	25	FX372
FX367	8	10	12.75	32	FX373
FX368	10	12	16	40	FX374
FX369	12	15	16	50	FX375

## Cone Pointed Set Screws

**FX386**  
M10x40mm

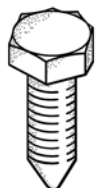

# CHANNEL SUPPORT SYSTEMS

## Fittings & Brackets

- Brackets comply with BS 6946
- Hot Dipped Galvanised to BS EN ISO 1461 unless otherwise stated
- All dimensions are in millimetres

### Flat Plate Fittings

- CB101/6** (M6 fixing)
- CB101/8** (M8 fixing)
- CB101/10** (M10 fixing)
- CB101/12** (M12 fixing)

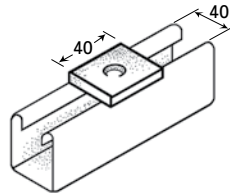

**CB101/(size)**

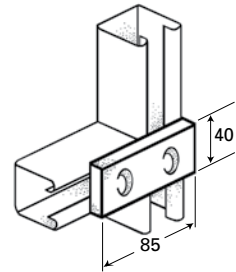

**CB102**

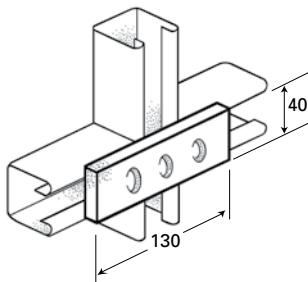

**CB103**

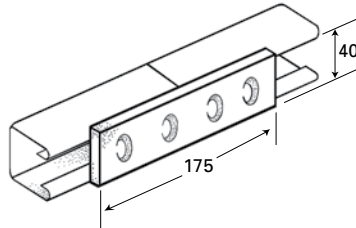

**CB104**

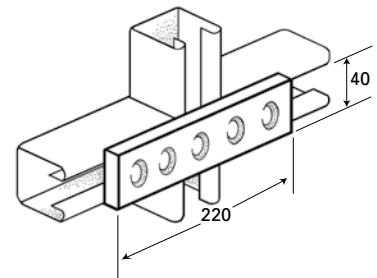

**CB105**

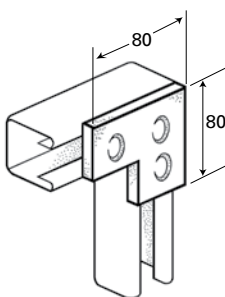

**CB107**

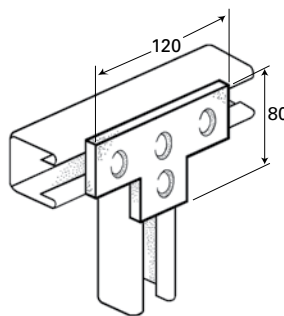

**CB108**

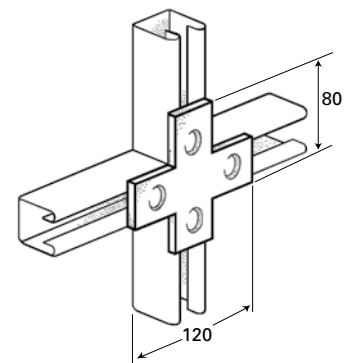

**CB109**

# CHANNEL SUPPORT SYSTEMS

## Right Angle Brackets

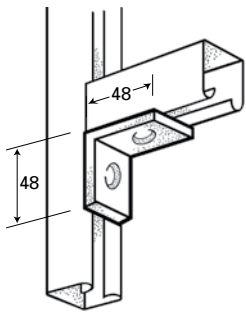

CB201

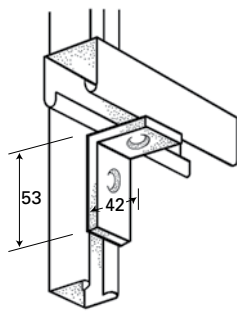

CB202

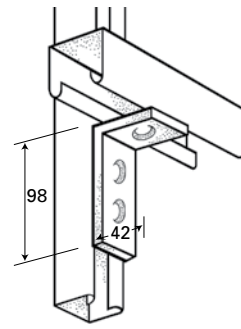

CB203

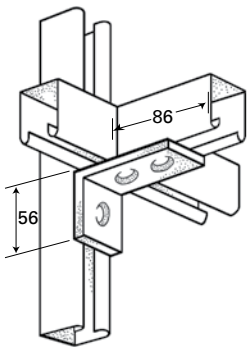

CB204

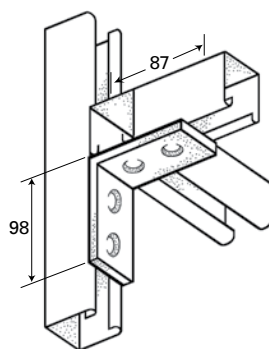

CB205

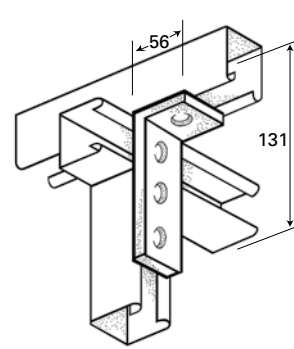

CB206

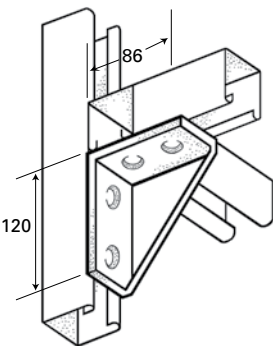

CB207

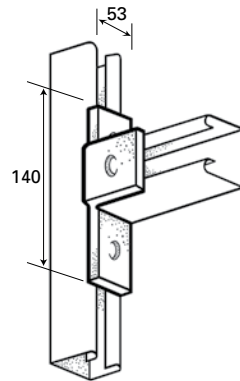

CB209

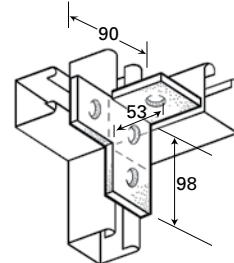

CB210

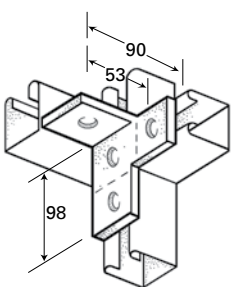

CB211

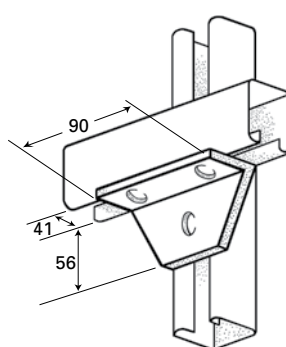

CB214

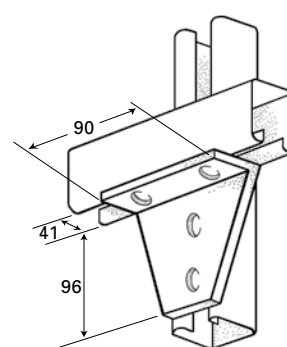



CB215

# CHANNEL SUPPORT SYSTEMS

## Z Brackets

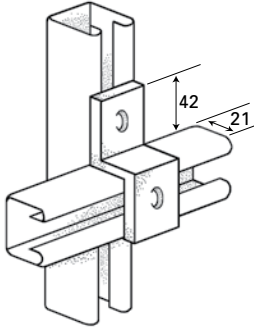
**CB301** Shallow Channel 



**CB302** Deep Channel 

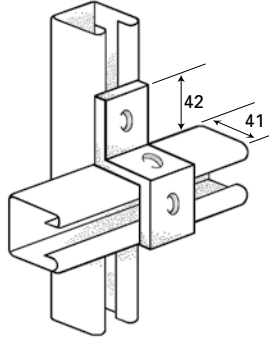

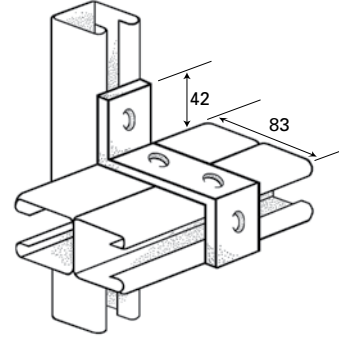

**CB303** Back to Back 



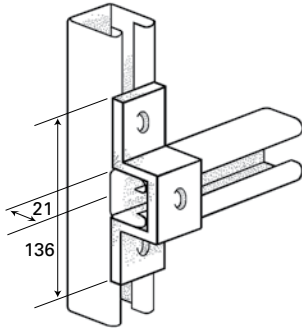

## U Brackets

**CB401** Shallow Channel 

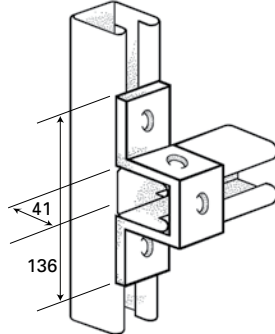

**CB402** Deep Channel 



**CB403** Back to Back 

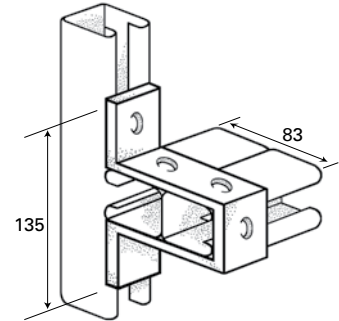

Holes on one side of bracket only

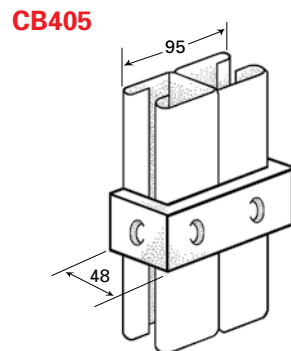
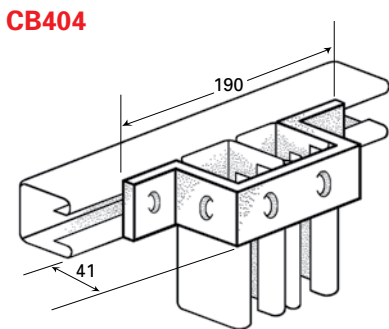

# CHANNEL SUPPORT SYSTEMS

## Angled Brackets

**CB501**

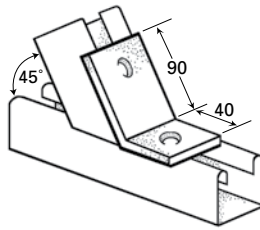

**CB503**

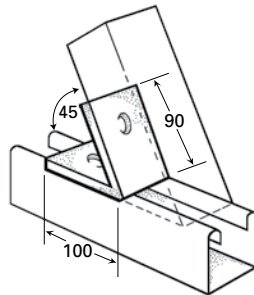

**CB504**

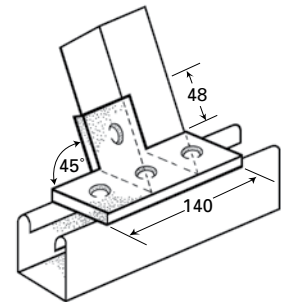

## External Jointing Channel

**CB603**



Shallow Channel

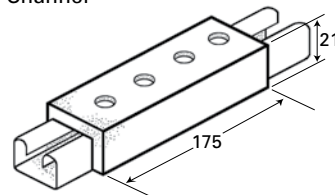

**CB604**



Deep Channel

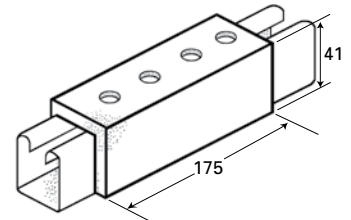

## Internal Jointing Channel

Galvanised to BS EN 10346.

**CB605/21**



Shallow Channel

**CB605/41**



Deep Channel

**CB606/21**



Shallow Channel

**CB606/41**



Deep Channel

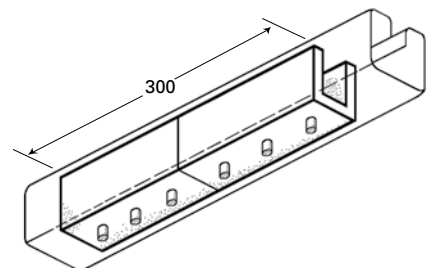
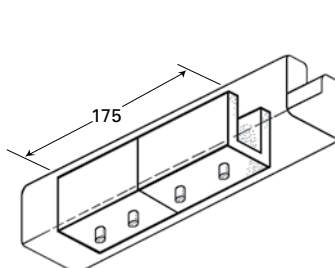

# CHANNEL SUPPORT SYSTEMS

## Base Plates

**CB701**

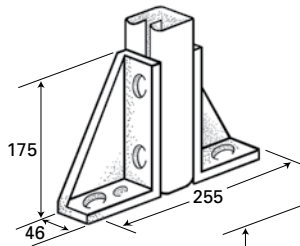
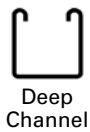

**CB702**

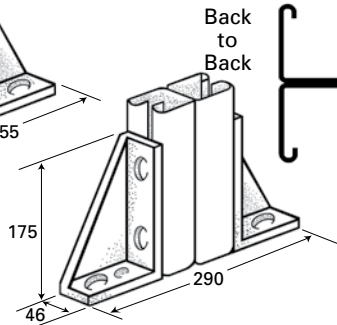

**CB706**

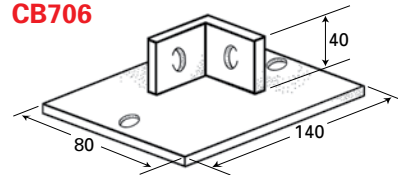

**CB707**

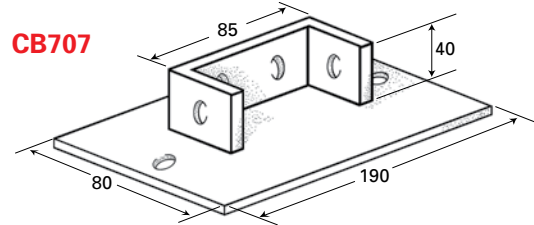

## Wing Bracket

**CB803**

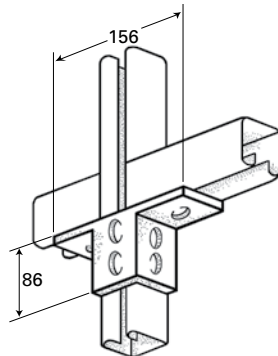

## Beam Clamps

Must be used in pairs.  
Cone point supplied.

**CB901**

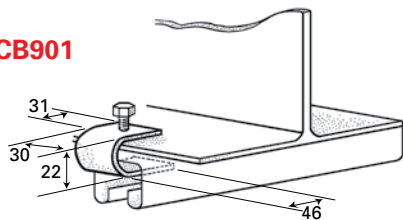

**CB902**

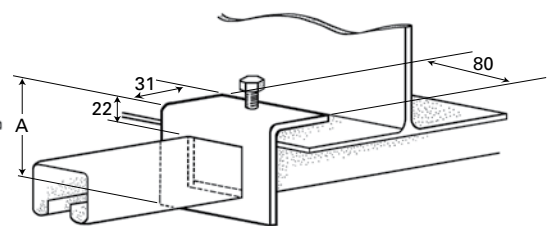
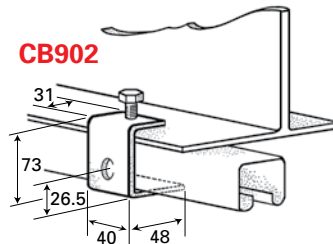

**CB903/21** Shallow A = 66mm

**CB903/41** Deep & Shallow Back to Back  
A = 84mm

**CB903/82** Deep Back to Back A = 134mm

**CB904**

Deep, Shallow &  
Shallow Back to Back

**CB905**

Deep Back to Back  
Must be used in pairs.  
U Bolt nuts and washers  
supplied.

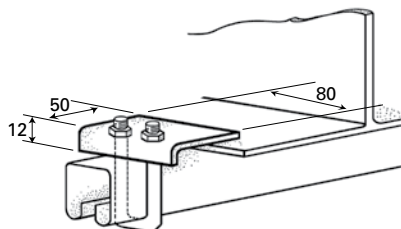

**CB906**

Must be used in pairs.  
Cone point supplied.

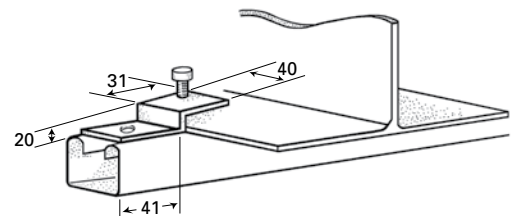

**CB907**

Must be used in pairs.  
Set screw and channel  
nut required.  
Please order separately.

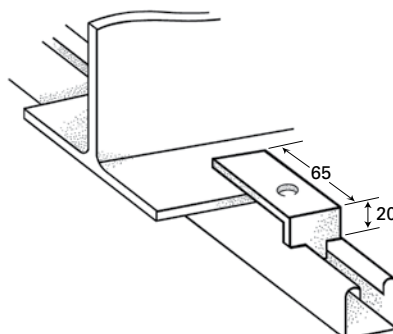



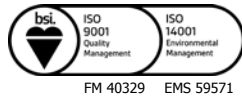

## CONDITIONS OF SALE

All Philip Grahame International Ltd. products are sold subject to our Standard Conditions of Quotation Contract and Sale in force at that time, a copy of which is available on request.

We reserve the right to make any alterations to the information contained in this brochure which we consider to be either necessary or advantageous.

This brochure is designed to provide only preliminary information on the products and services provided by Philip Grahame International Ltd. and is not a contract. The company does not accept liability for loss or damage arising from failure to follow its instructions in respect of its products or from variations to products not agreed by it.

© This brochure is the sole copyright of Philip Grahame International Ltd. and should not be reproduced in part or in full without prior permission (2019)



Member of  **NIEDAX GROUP**

Philip Grahame International Limited  
Unit 7 Lonebarn Link  
Springfield Business Park  
Chelmsford  
Essex  
CM2 5AR  
United Kingdom

+44 (0)1245 451717

[sales@philipgrahame.co.uk](mailto:sales@philipgrahame.co.uk)

[www.philipgrahame.co.uk](http://www.philipgrahame.co.uk)